

3.3V

R16	R18	$V_{out}=1.25(1+R16/R18)$	误差(%)
2.20	1.33	3.3177	0.54
2.32	1.43	3.2780	-0.67
2.49	1.50	3.3250	0.76

1.8V

R17	R19	$V_{out}=1.25(1+R17/R19)$	误差(%)
5.60	12.7	1.8012	0.07
1.33	3.00	1.8042	0.23
2.49	5.60	1.8058	0.32

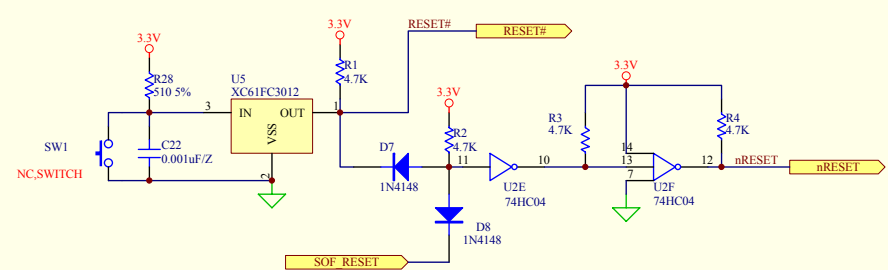
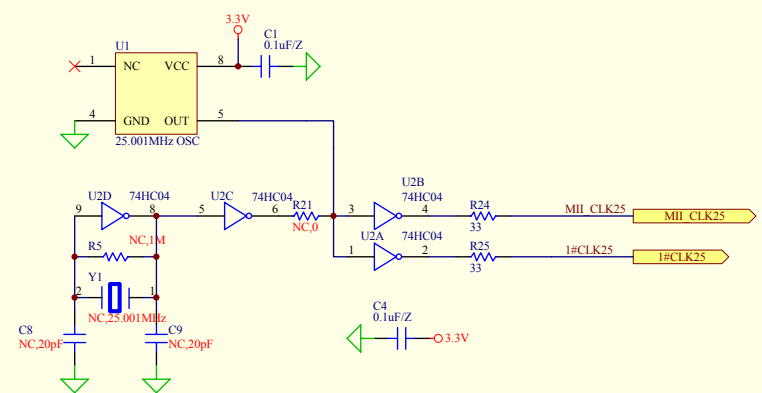
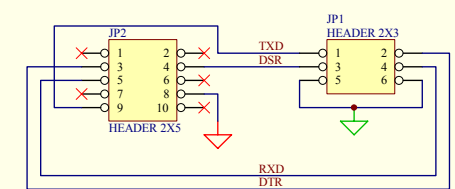
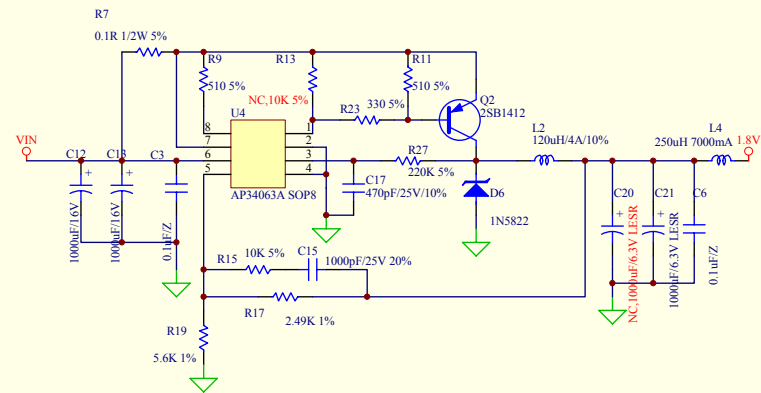
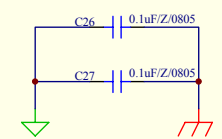
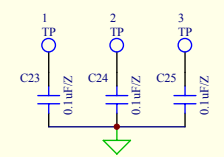

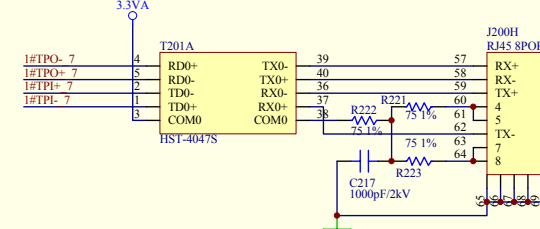
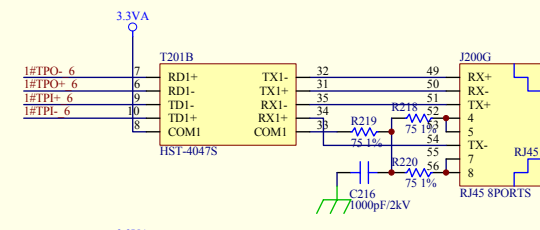
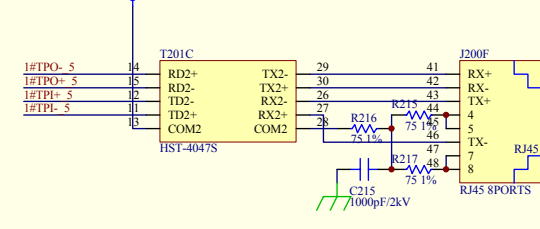
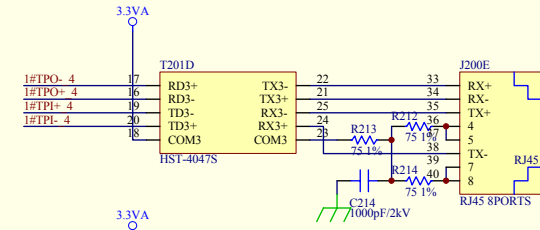
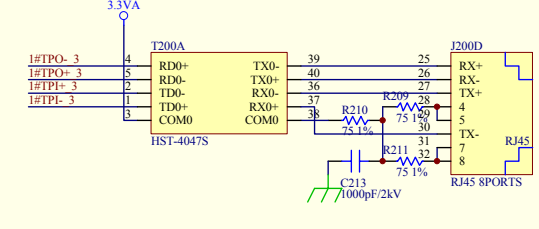
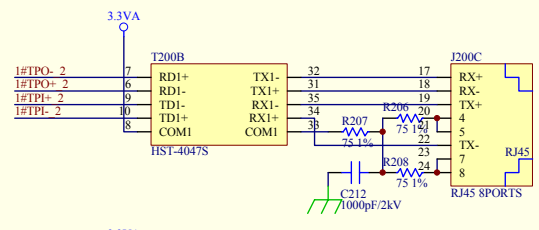
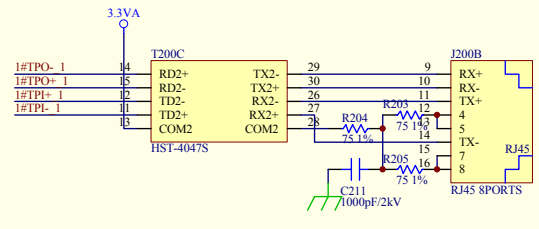
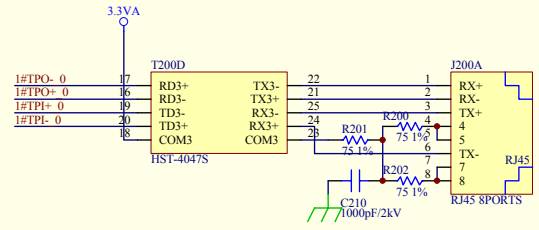
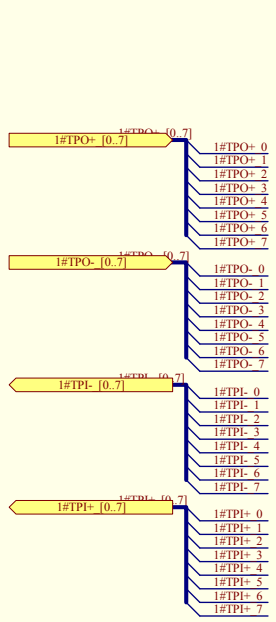
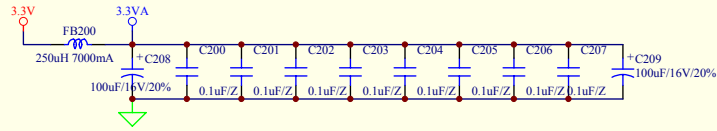

Title			
TCL Communication Equipment (HuiZhou) Co.,LTD			
Size	A3	Number	RJ45&X'FM
Revision	V1.2		
Date:	2004.10.18		Sheet: 4 OF 4