

Title		
<Title>		
Size	Document Number	Rev
A	<Doc>	A1
Date:	Monday, October 08, 2001	Sheet 1 of 1

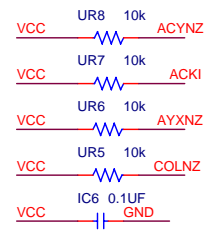

Title <Title>		
Size A	Document Number <Doc>	Rev A1
Date:	Monday, October 08, 2001	Sheet 1 of 1

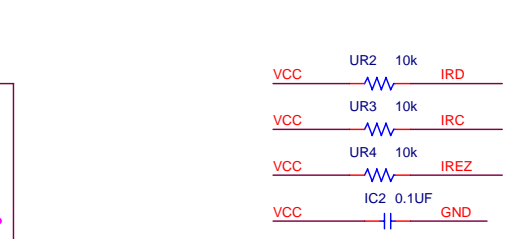
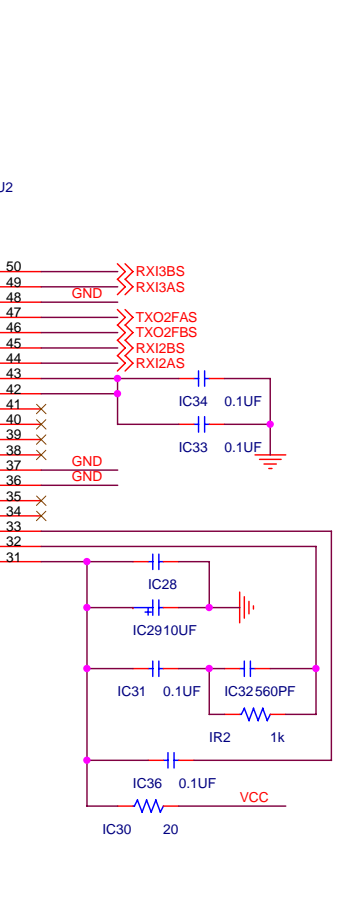
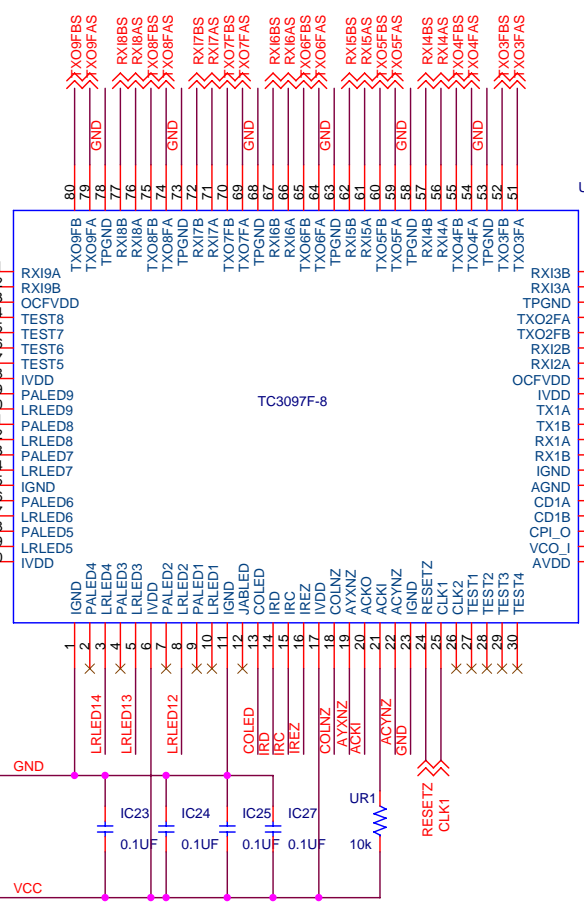
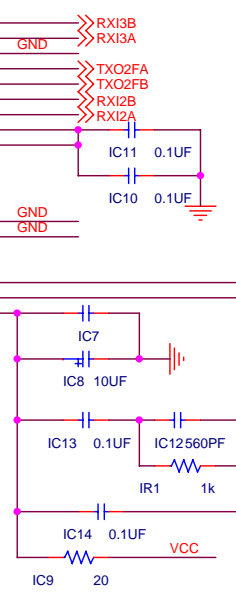
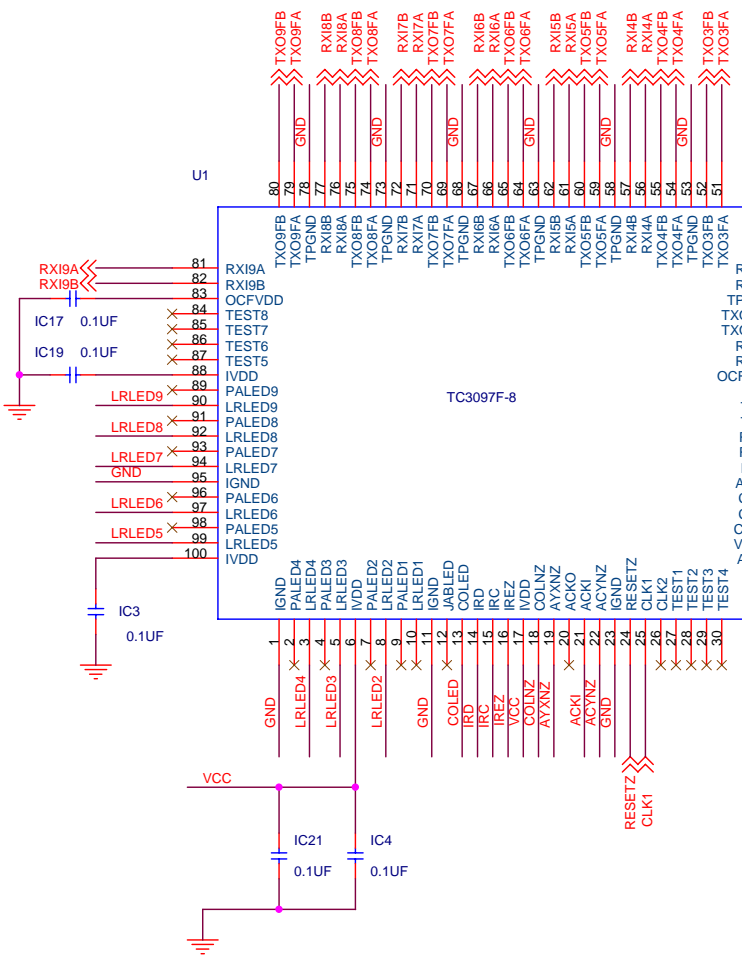
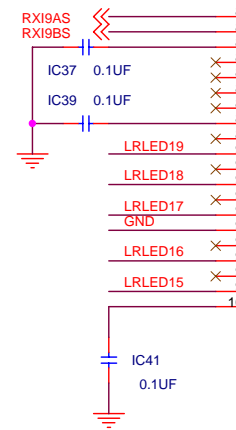
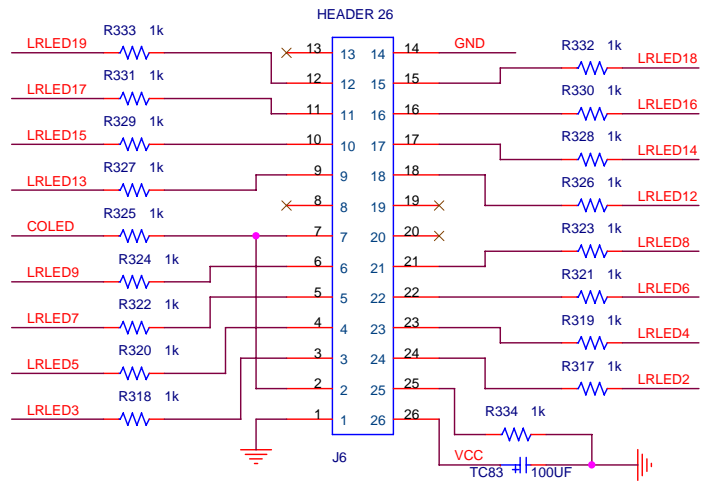
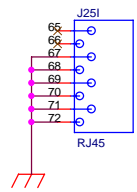
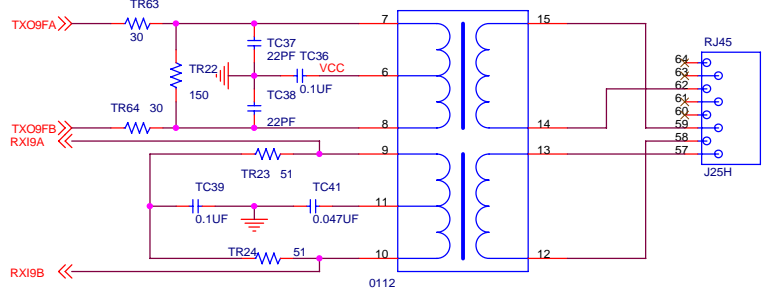
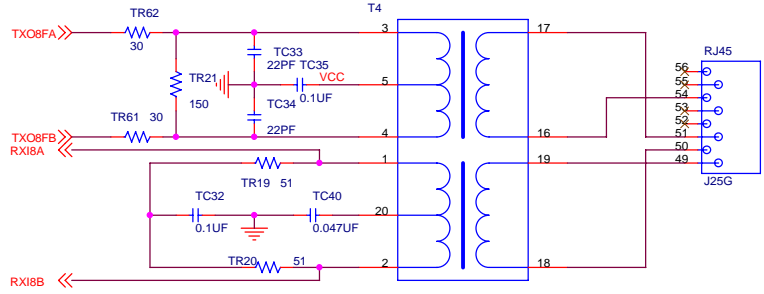
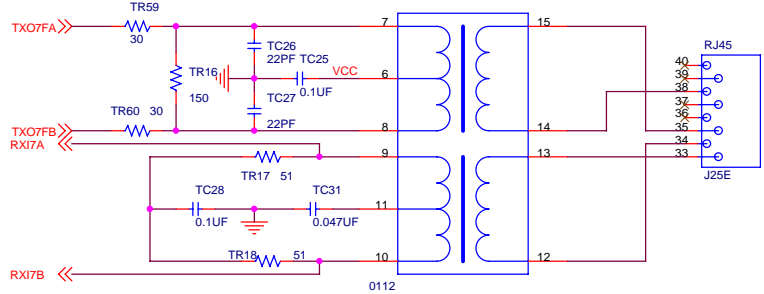
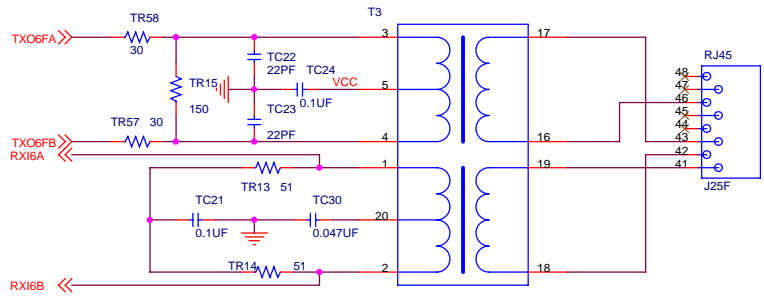
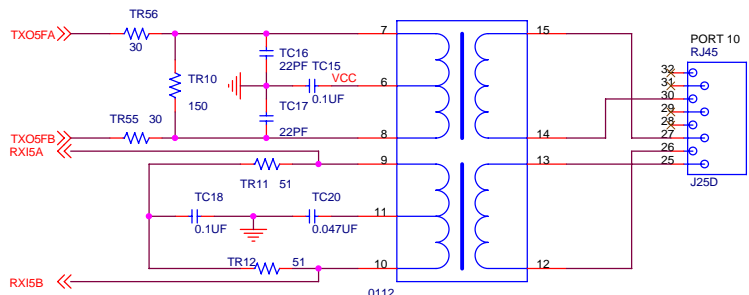
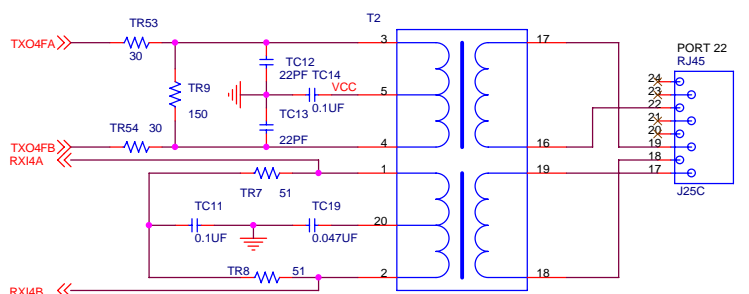
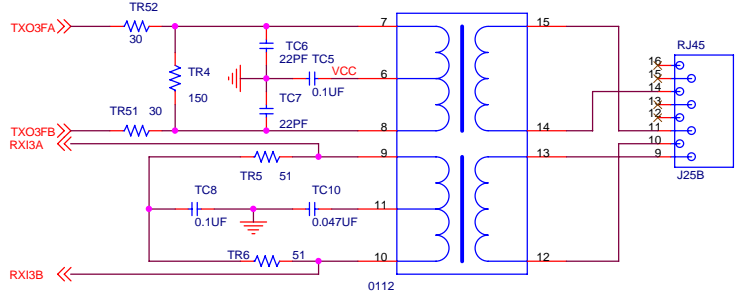
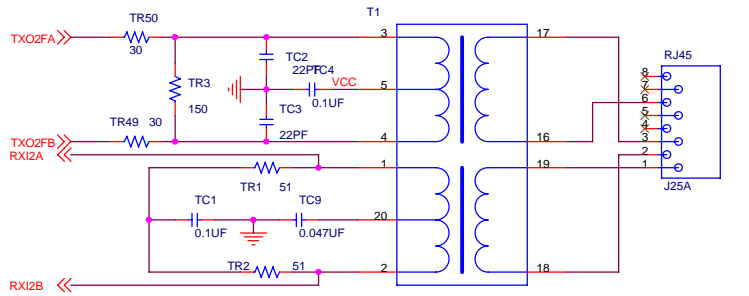

VCC >> VCC

Title <Title>		
Size A	Document Number <Doc>	Rev A1
Date:	Monday, October 08, 2001	Sheet 1 of 1

