

TC9208M current:  
450mA @ 1.8v  
200mA @ 3.3v

# TC9208M

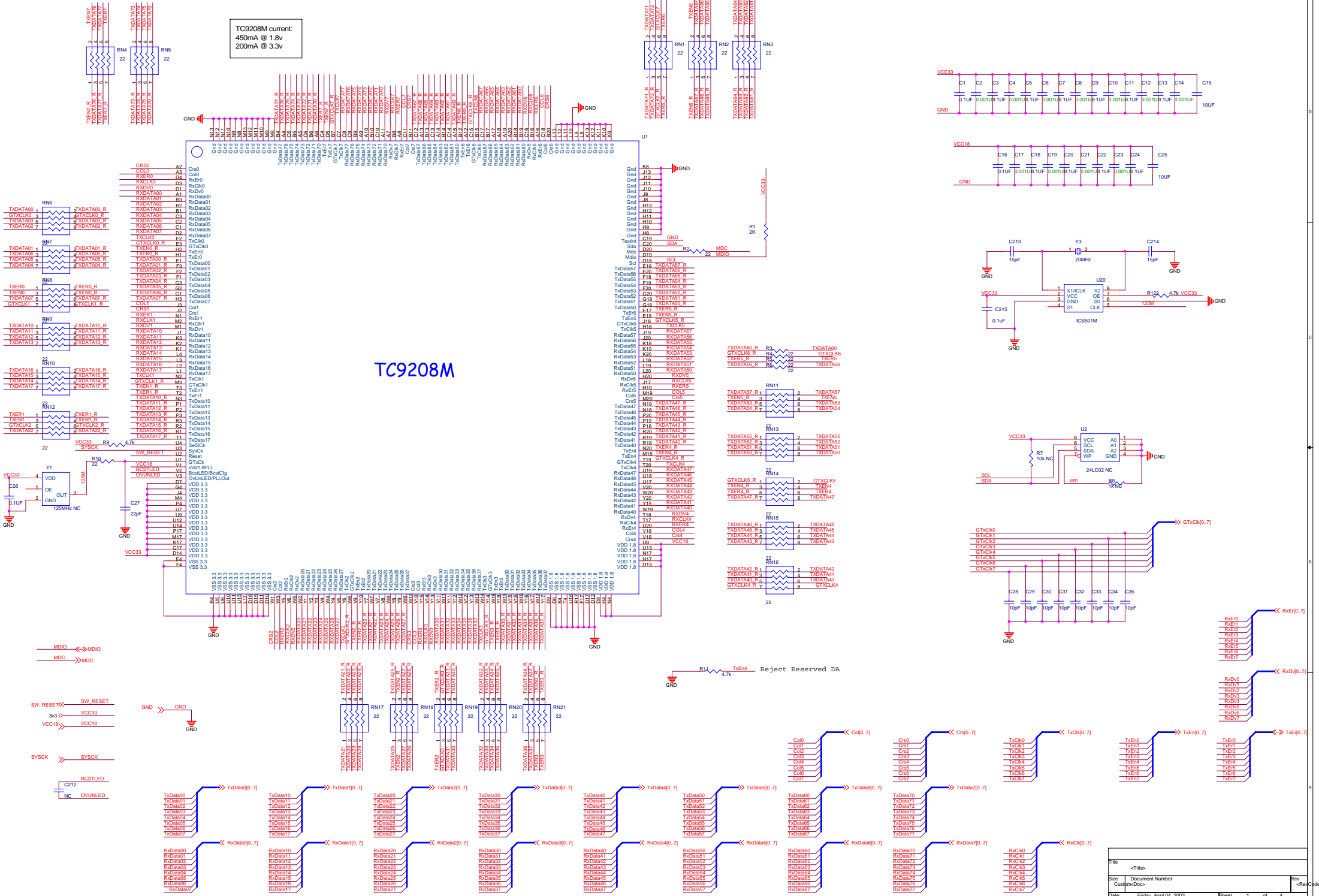

File	<Title>	Rev	<Rev>
Size	Document Number		
Path	Output/Doc		
Date	Friday, April 03, 2009	Sheet	1 of 4



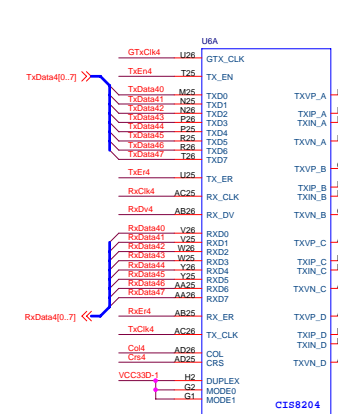

### PHY Port 4-7

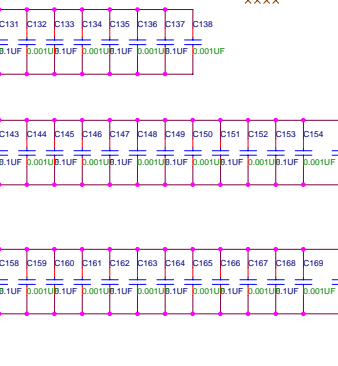
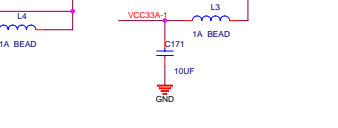
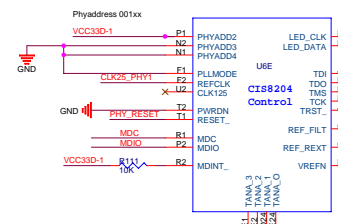
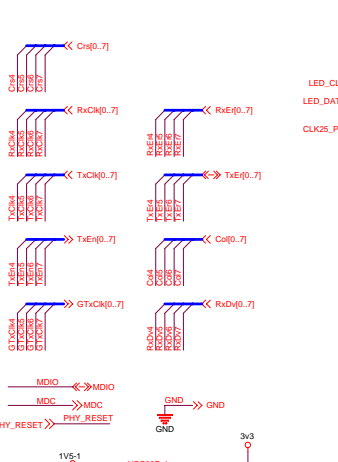
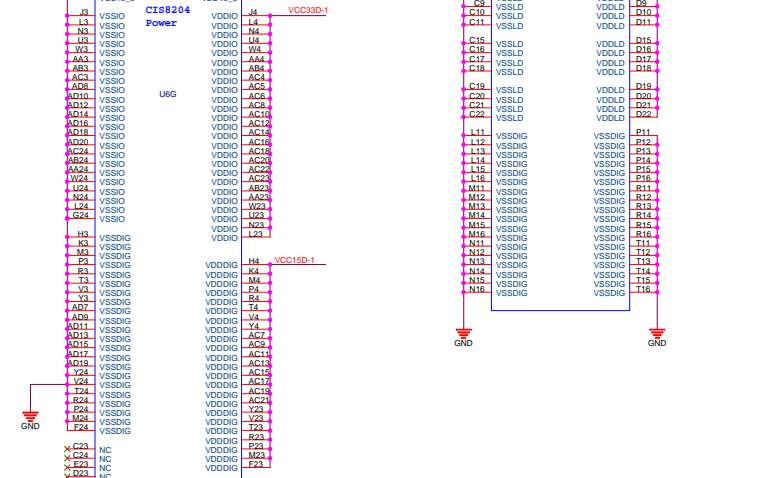
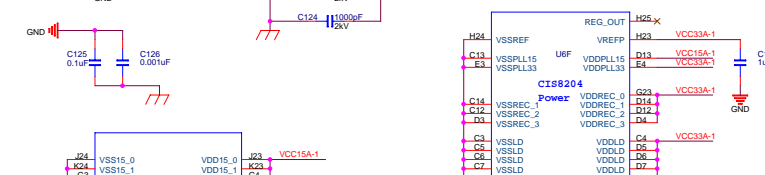
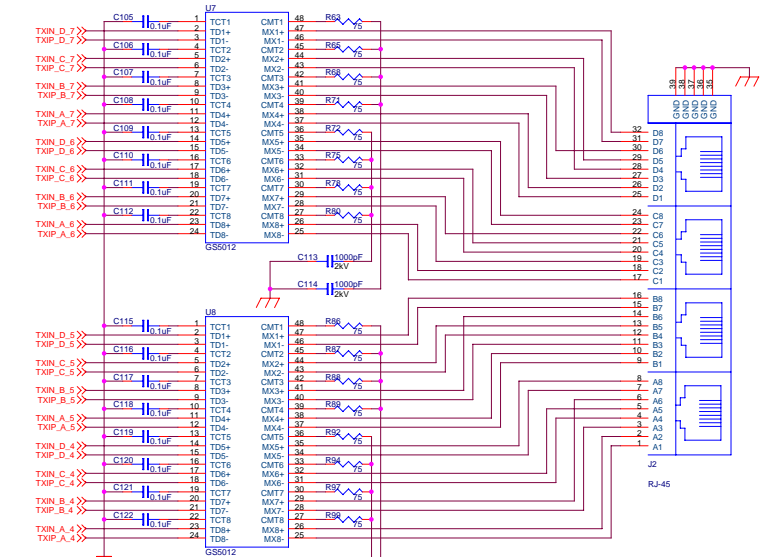
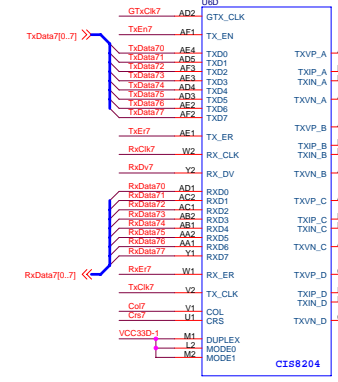
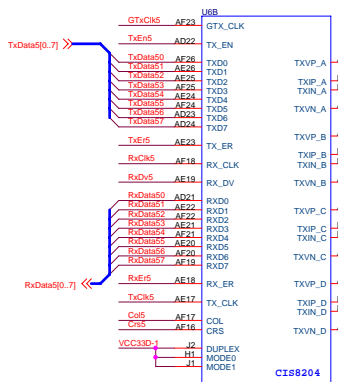

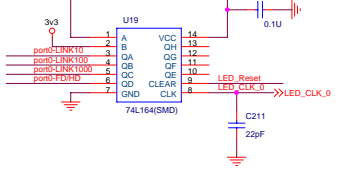
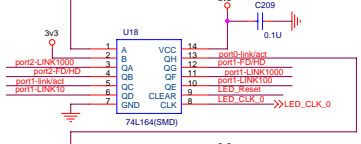
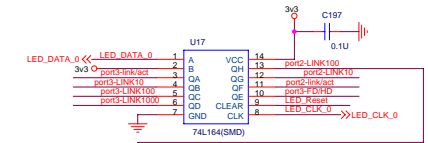
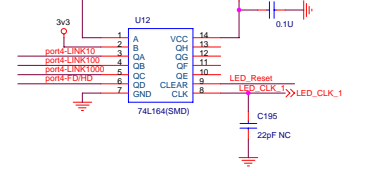
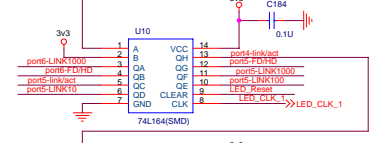
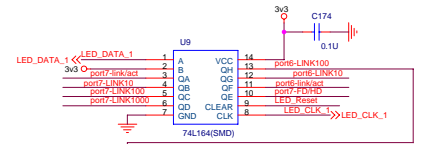
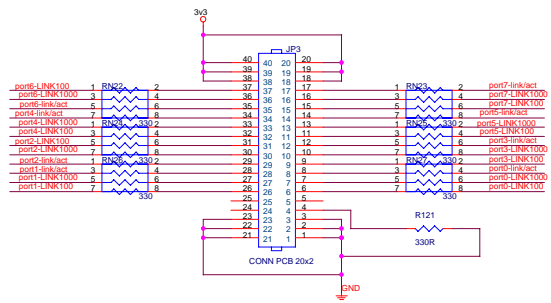
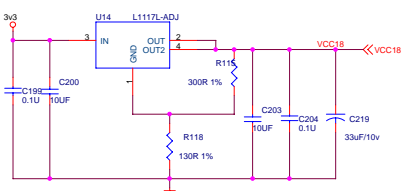
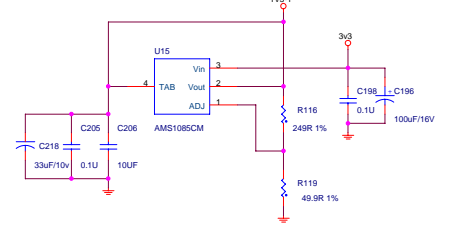
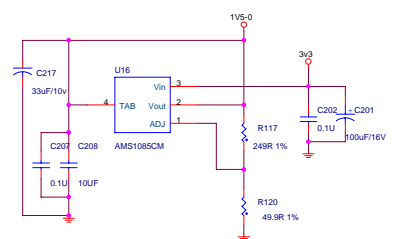
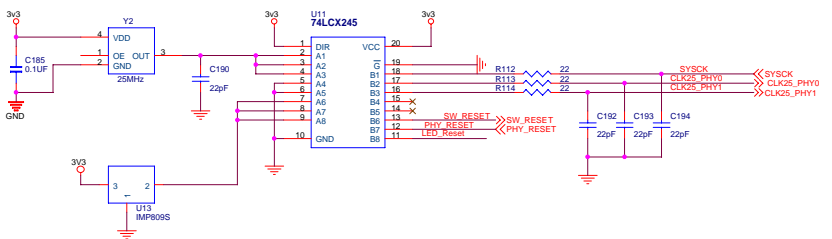
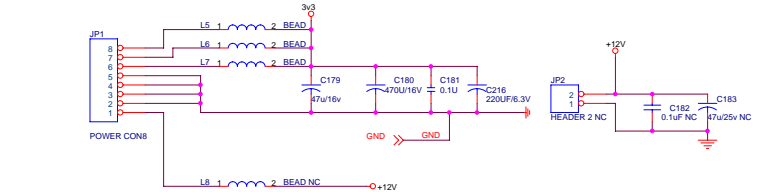
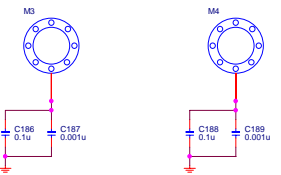
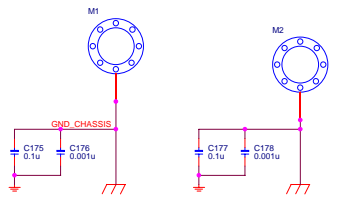

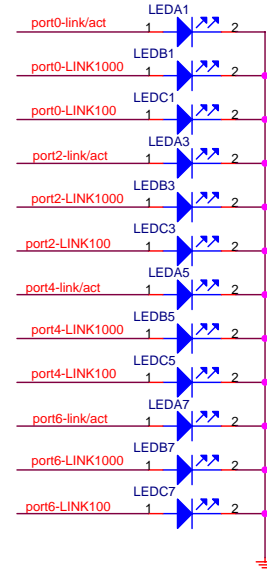
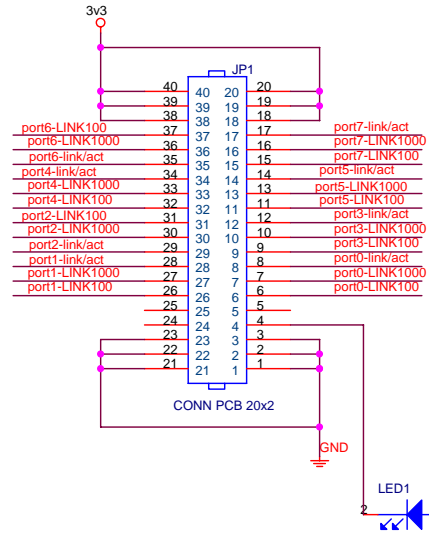
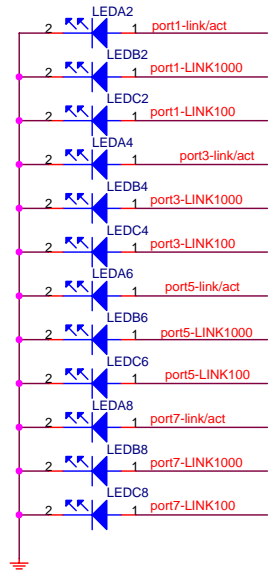

<b>Shenzhen TP-LINK Technologies Co.,LTD.</b>		
Title		LED072
Size B	Document Number	TL-SG1008
Date:	Thursday, July 03, 2003	Rev 1.0
Sheet 1 of 1		1