

PB2 pin37 BOOT1
pin94 BOOT0
PB4 NJTRST

STM32F103VE

U1 STM32F103VE

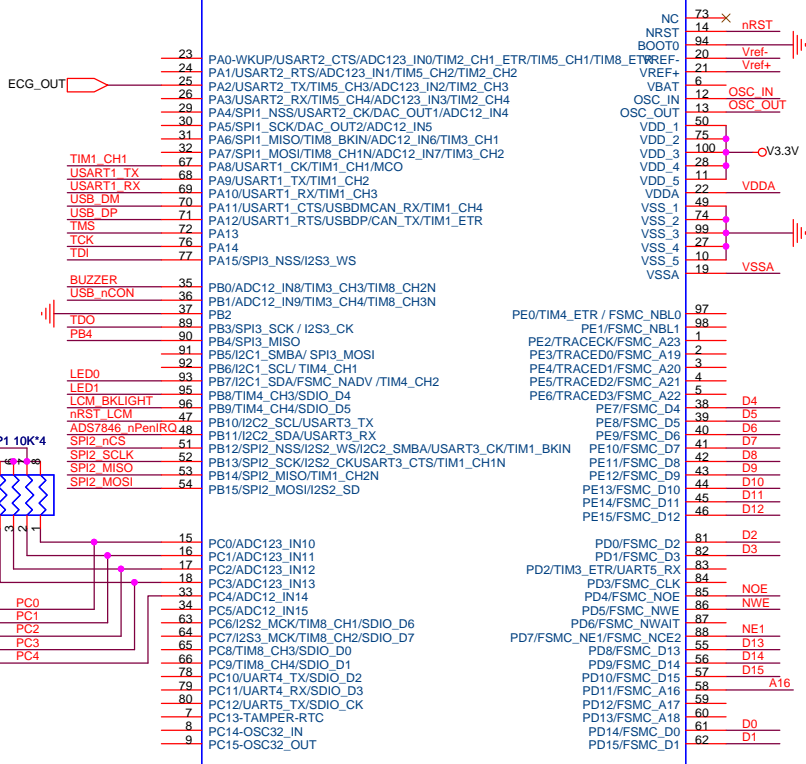

JLINK

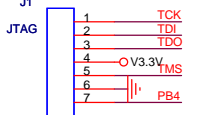

5 DIRECTION KEY

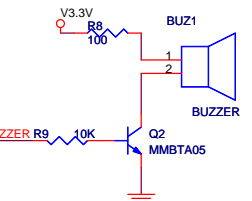
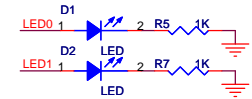
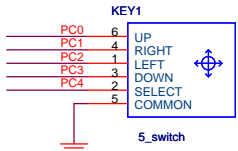

2.4" TFT

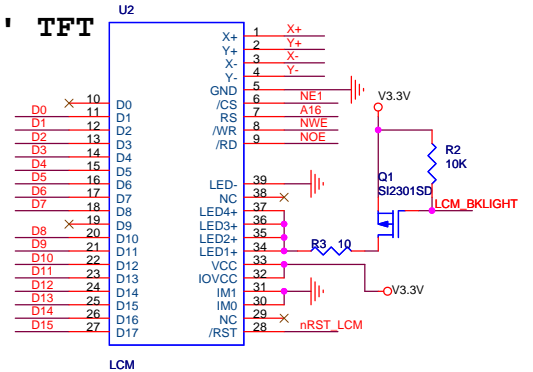

ADS7846 TOUCH

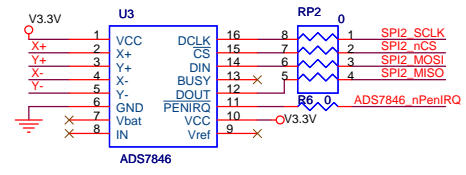

reserved LCD BUS

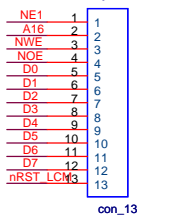

USB COMMUNICATION & POWER SUPPLY

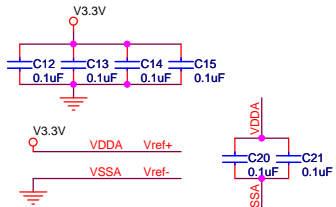
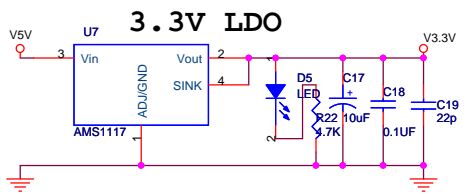
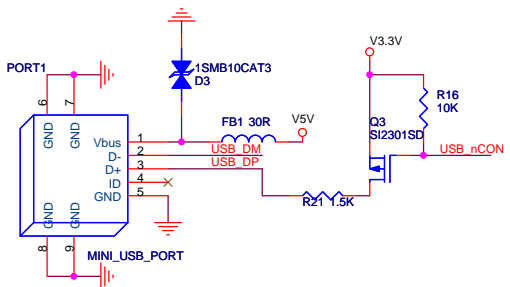

ECG SIGNAL AMPLIFICATION

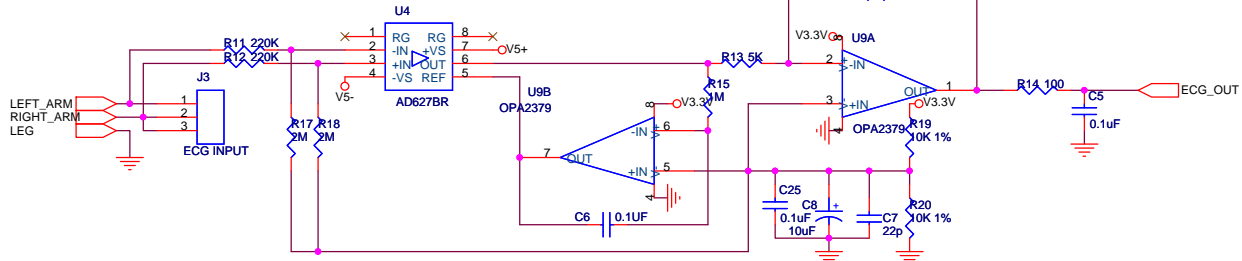

USART1_TTL

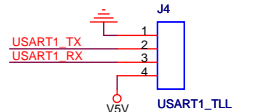

+5V GENERATOR

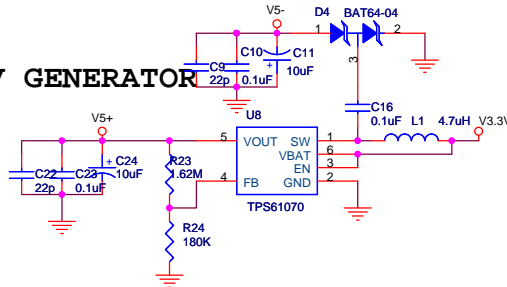

File	<Title>	YEMI_ECG 09/2009	Rev
Size	Document Number		Vo. 1
A3	<Doc>		
Date:	Saturday, September 12, 2009	Sheet	1 of 1