



# SOT23, Single-Supply, Low-Noise, Low-Distortion, Rail-to-Rail Op Amps

MAX4249-MAX4257

## General Description

The MAX4249-MAX4257 low-noise, low-distortion operational amplifiers offer Rail-to-Rail® outputs and single-supply operation down to 2.4V. They draw only 400µA of quiescent supply current per amplifier while featuring ultra-low distortion (0.0002% THD), as well as low input voltage noise density (7.9nV/√Hz) and low input current noise density (0.5fA/√Hz). These features make the devices an ideal choice for portable/battery-powered applications that require low distortion and/or low noise.

For additional power conservation, the MAX4249/MAX4251/MAX4253/MAX4256 offer a low-power shutdown mode that reduces supply current to 0.5µA and puts the amplifiers' outputs into a high-impedance state. The MAX4249-MAX4257's outputs swing rail-to-rail and their input common-mode voltage range includes ground. The MAX4250-MAX4254 are unity-gain stable; the MAX4249/MAX4255/MAX4256/MAX4257 are internally compensated for gains of 10V/V or greater. The single MAX4250/MAX4255 are available in a space-saving, 5-pin SOT23 package.

## Applications

Portable/Battery-Powered Equipment  
 Medical Instrumentation  
 ADC Buffers  
 Digital Scales  
 Strain Gauges  
 Sensor Amplifiers  
 Portable Communications Devices

**Pin Configurations and Typical Operating Circuit appear at end of data sheet.**

## Features

- ◆ **Low Input Voltage Noise Density: 7.9nV/√Hz**
- ◆ **Low Input Current Noise Density: 0.5fA/√Hz**
- ◆ **Low Distortion: 0.0002% THD (1kΩ load)**
- ◆ **400µA Quiescent Supply Current per Amplifier**
- ◆ **Single-Supply Operation from +2.4V to +5.5V**
- ◆ **Input Common-Mode Voltage Range Includes Ground**
- ◆ **Outputs Swing within 8mV of Rails with a 10kΩ Load**
- ◆ **3MHz GBW Product, Unity-Gain Stable (MAX4250-MAX4254)**  
**22MHz GBW Product, Stable with  $A_V \geq 10V/V$  (MAX4249/MAX4255/MAX4256/MAX4257)**
- ◆ **Excellent DC Characteristics:**  
 **$V_{OS} = 70\mu V$**   
 **$I_{BIAS} = 1pA$**   
**Large-Signal Voltage Gain = 116dB**
- ◆ **Low-Power Shutdown Mode:**  
**Reduces Supply Current to 0.5µA**  
**Places Outputs in a High-Impedance State**
- ◆ **400pF Capacitive-Load Handling Capability**
- ◆ **Available in Space-Saving SOT23 and µMAX Packages**

## Ordering Information

PART	TEMP. RANGE	PIN-PACKAGE	SOT TOP MARK
MAX4249ESD	-40°C to +85°C	14 SO	—
MAX4249EUB	-40°C to +85°C	10 µMAX	—
MAX4250EUK-T	-40°C to +85°C	5 SOT23-5	ACCI

Ordering Information continued at end of data sheet.

## Selector Guide

PART	GAIN BANDWIDTH (MHz)	MINIMUM STABLE GAIN (V/V)	NO. OF AMPLIFIERS PER PACKAGE	SHUTDOWN MODE	PACKAGES
MAX4249	22	10	2	Yes	10-pin µMAX, 14-pin SO
MAX4250	3	1	1	—	5-pin SOT23
MAX4251	3	1	1	Yes	8-pin µMAX/SO
MAX4252	3	1	2	—	8-pin µMAX/SO
MAX4253	3	1	2	Yes	10-pin µMAX, 14-pin SO
MAX4254	3	1	4	—	14-pin SO
MAX4255	22	10	1	—	5-pin SOT23
MAX4256	22	10	1	Yes	8-pin µMAX/SO
MAX4257	22	10	2	—	8-pin µMAX/SO

Rail-to-Rail is a registered trademark of Nippon Motorola Ltd.



Maxim Integrated Products 1

**For free samples & the latest literature: <http://www.maxim-ic.com>, or phone 1-800-998-8800.  
 For small orders, phone 408-737-7600 ext. 3468.**

# SOT23, Single-Supply, Low-Noise, Low-Distortion, Rail-to-Rail Op Amps

## ABSOLUTE MAXIMUM RATINGS

Power-Supply Voltage ( $V_{DD}$ to $V_{SS}$ )	+6.0V to -0.3V	8-Pin SO (derate 5.88mW/°C above +70°C)	471mW
Analog Input Voltage ( $IN_+$ , $IN_-$ )	( $V_{DD} + 0.3V$ ) to ( $V_{SS} - 0.3V$ )	10-Pin $\mu$ MAX (derate 5.6mW/°C above +70°C)	444mW
SHDN Input Voltage	+6.0V to ( $V_{SS} - 0.3V$ )	14-Pin SO (derate 8.33mW/°C above +70°C)	667mW
Output Short-Circuit Duration to Either Supply	Continuous	Operating Temperature Range	-40°C to +85°C
Continuous Power Dissipation ( $T_A = +70^\circ\text{C}$ )		Junction Temperature	+150°C
5-Pin SOT23 (derate 7.1mW/°C above +70°C)	571mW	Storage Temperature Range	-65°C to +160°C
8-Pin $\mu$ MAX (derate 4.10mW/°C above +70°C)	330mW	Lead Temperature (soldering, 10sec)	+300°C

Stresses beyond those listed under "Absolute Maximum Ratings" may cause permanent damage to the device. These are stress ratings only, and functional operation of the device at these or any other conditions beyond those indicated in the operational sections of the specifications is not implied. Exposure to absolute maximum rating conditions for extended periods may affect device reliability.

## ELECTRICAL CHARACTERISTICS

( $V_{DD} = +5V$ ,  $V_{SS} = 0V$ ,  $V_{CM} = 0V$ ,  $V_{OUT} = V_{DD}/2$ ,  $R_L$  tied to  $V_{DD}/2$ ,  $\overline{\text{SHDN}} = V_{DD}$  or open,  $T_A = -40^\circ\text{C}$  to  $+85^\circ\text{C}$ , unless otherwise noted. Typical values are at  $T_A = +25^\circ\text{C}$ .) (Notes 1, 2)

PARAMETER	SYMBOL	CONDITIONS	MIN	TYP	MAX	UNITS
Supply-Voltage Range	$V_{DD}$	(Note 3)	2.4		5.5	V
Quiescent Supply Current per Amplifier	$I_Q$	Normal mode		400		$\mu\text{A}$
			$V_{DD} = 3V$			
			$V_{DD} = 5V$	420	575	
		Shutdown mode ( $\overline{\text{SHDN}} = V_{SS}$ ) (Note 1)		0.5	1.5	
Input Offset Voltage	$V_{OS}$			$\pm 0.07$	$\pm 0.75$	mV
Input Offset Voltage Tempco				0.3		$\mu\text{V}/^\circ\text{C}$
Input Bias Current	$I_B$	(Note 4)		$\pm 1$	$\pm 100$	pA
Input Offset Current	$I_{OS}$	(Note 4)		$\pm 1$	$\pm 100$	pA
Differential Input Resistance	$R_{IN}$			1000		$\text{G}\Omega$
Input Common-Mode Voltage Range	$V_{CM}$	Guaranteed by CMRR test	-0.2		$V_{DD} - 1.1$	V
Common-Mode Rejection Ratio	CMRR	$V_{SS} - 0.2V \leq V_{CM} \leq V_{DD} - 1.1V$	70	115		dB
Power-Supply Rejection Ratio	PSRR	$V_{DD} = 2.4V$ to $5.5V$	75	100		dB
Large-Signal Voltage Gain	$A_V$	$R_L = 10\text{k}\Omega$ to $V_{DD}/2$ , $V_{OUT} = 25\text{mV}$ to $4.97V$	80	116		dB
		$R_L = 1\text{k}\Omega$ to $V_{DD}/2$ , $V_{OUT} = 150\text{mV}$ to $4.75V$	80	112		
Output Voltage Swing	$V_{OUT}$	$ V_{IN+} - V_{IN-}  \geq 10\text{mV}$ , $R_L = 10\text{k}\Omega$ to $V_{DD}/2$	$V_{DD} - V_{OH}$	8	25	mV
			$V_{OL} - V_{SS}$	7	20	
		$ V_{IN+} - V_{IN-}  \geq 10\text{mV}$ , $R_L = 1\text{k}\Omega$ to $V_{DD}/2$	$V_{DD} - V_{OH}$	77	200	
			$V_{OL} - V_{SS}$	47	100	
Output Short-Circuit Current	$I_{SC}$		68		mA	
Output Leakage Current	$I_{LEAK}$	Shutdown mode ( $\overline{\text{SHDN}} = V_{SS}$ ), $V_{OUT} = V_{SS}$ to $V_{DD}$		0.001	1.0	$\mu\text{A}$
$\overline{\text{SHDN}}$ Logic Low	$V_{IL}$			$0.2 \times V_{DD}$		V
$\overline{\text{SHDN}}$ Logic High	$V_{IH}$		$0.8 \times V_{DD}$			V
$\overline{\text{SHDN}}$ Input Current	$I_{IL}/I_{IH}$	$\overline{\text{SHDN}} = V_{SS}$ to $V_{DD}$		0.5	1.5	$\mu\text{A}$
Input Capacitance				11		pF

# SOT23, Single-Supply, Low-Noise, Low-Distortion, Rail-to-Rail Op Amps

MAX4249-MAX4257

## ELECTRICAL CHARACTERISTICS (continued)

( $V_{DD} = +5V$ ,  $V_{SS} = 0V$ ,  $V_{CM} = 0V$ ,  $V_{OUT} = V_{DD}/2$ ,  $R_L$  tied to  $V_{DD}/2$ ,  $\overline{SHDN} = V_{DD}$  or open,  $T_A = -40^\circ C$  to  $+85^\circ C$ , unless otherwise noted. Typical values are at  $T_A = +25^\circ C$ .) (Notes 1, 2)

PARAMETER	SYMBOL	CONDITIONS		MIN	TYP	MAX	UNITS
Gain-Bandwidth Product	GBW	MAX4250-MAX4254		3			MHz
		MAX4249/MAX4255/MAX4256/MAX4257		22			
Slew Rate	SR	MAX4250-MAX4254		0.3			V/ $\mu$ s
		MAX4249/MAX4255/MAX4256/MAX4257		2.1			
Peak-to-Peak Input Noise Voltage	$e_n(p-p)$	f = 0.1Hz to 10Hz		760			nVp-p
Input Voltage Noise Density	$e_n$	f = 10Hz		27			nV/ $\sqrt{Hz}$
		f = 1kHz		8.9			
		f = 30kHz		7.9			
Input Current Noise Density	$i_n$	f = 1kHz		0.5			fA/ $\sqrt{Hz}$
Total Harmonic Distortion plus Noise	THD+N	MAX4250-MAX4254, $A_V = +1V/V$ , $V_{OUT} = 2Vp-p$ , $R_L = 1k\Omega$ to GND (Note 5)	f = 1kHz	0.0004			%
			f = 20kHz	0.006			
		MAX4249/MAX4255/MAX4256/MAX4257, $A_V = +10V/V$ , $R_F = 100k\Omega$ , $R_G = 11k\Omega$ , $V_{OUT} = 4Vp-p$ , $R_L = 10k\Omega$ to GND (Note 5)	f = 1kHz	0.0012			
			f = 20kHz	0.007			
Capacitive-Load Stability		No sustained oscillations		400			pF
Gain Margin	GM	MAX4250-MAX4254, $A_V = +1V/V$		10			dB
		MAX4249/MAX4255/MAX4256/MAX4257, $A_V = +10V/V$		12.5			
Phase Margin	$\Phi_M$	MAX4250-MAX4254, $A_V = +1V/V$		74			degrees
		MAX4249/MAX4255/MAX4256/MAX4257, $A_V = +10V/V$		68			
Settling Time		To 0.01%, $V_{OUT} = 2V$ step	MAX4250-MAX4254	6.7			$\mu$ s
			MAX4249/MAX4255/MAX4256/MAX4257	1.6			
Shutdown Delay Time	t <sub>SH</sub>	I <sub>VDD</sub> = 5% of normal operation	MAX4251/MAX4253	0.8			$\mu$ s
			MAX4249/MAX4256	1.2			
Enable Delay Time	t <sub>EN</sub>	$V_{OUT} = 2.5V$ , $V_{OUT}$ settles to 0.1%	MAX4251/MAX4253	8			$\mu$ s
			MAX4249/MAX4256	3.5			
Power-Up Delay Time	t <sub>PU</sub>	$V_{DD} = 0V$ to 5V step, $V_{OUT}$ stable to 0.1%		6			$\mu$ s

**Note 1:**  $\overline{SHDN}$  is available on the MAX4249/MAX4251/MAX4253/MAX4256 only.

**Note 2:** The MAX4249EUB, MAX425\_EU\_ specifications are 100% tested at  $T_A = +25^\circ C$ . Limits over the extended temperature range are guaranteed by design, not production tested.

**Note 3:** Guaranteed by the Power-Supply Rejection Ratio (PSRR) test.

**Note 4:** Guaranteed by design.

**Note 5:** Lowpass filter bandwidth is 22kHz for f = 1kHz, and 80kHz for f = 20kHz. Noise floor of test equipment = 10nV/ $\sqrt{Hz}$ .

# SOT23, Single-Supply, Low-Noise, Low-Distortion, Rail-to-Rail Op Amps

## Typical Operating Characteristics

( $V_{DD} = +5V$ ,  $V_{SS} = 0V$ ,  $V_{CM} = V_{OUT} = V_{DD}/2$ , input noise floor of test equipment =  $10nV/\sqrt{Hz}$  for all distortion measurements,  $T_A = +25^\circ C$ , unless otherwise noted.)

MAX4251/MAX4256 INPUT OFFSET VOLTAGE DISTRIBUTION

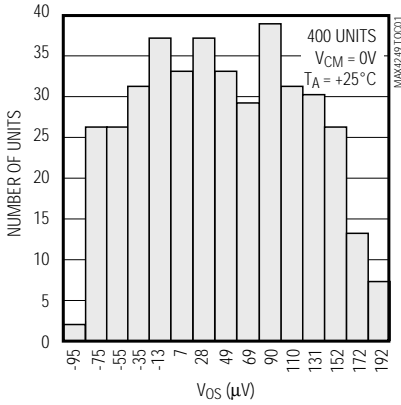

OFFSET VOLTAGE vs. TEMPERATURE

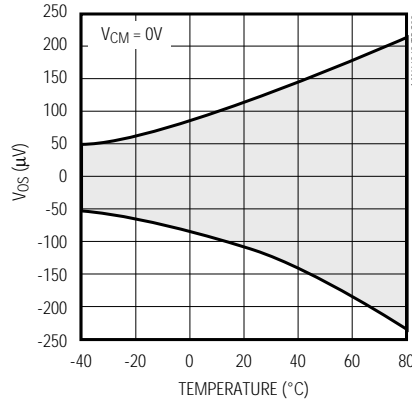

INPUT OFFSET VOLTAGE vs. COMMON-MODE INPUT VOLTAGE

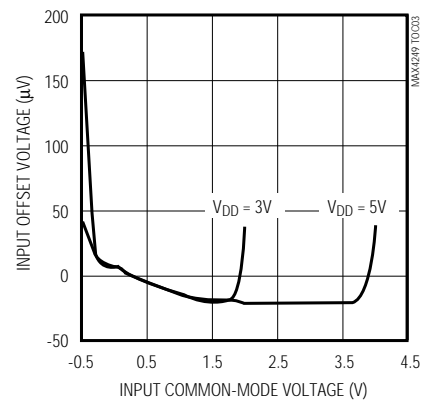

OUTPUT VOLTAGE vs. OUTPUT LOAD CURRENT

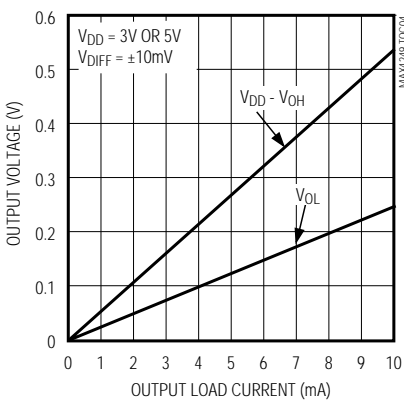

OUTPUT VOLTAGE SWING (VOH) vs. TEMPERATURE

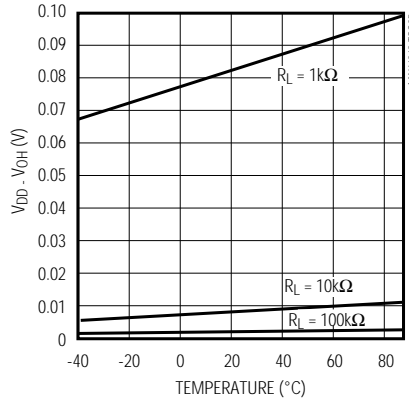

OUTPUT VOLTAGE SWING (VOL) vs. TEMPERATURE

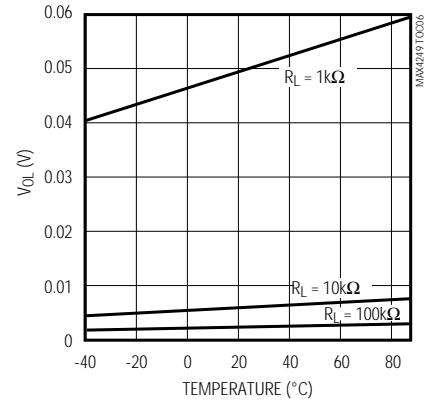

LARGE-SIGNAL VOLTAGE GAIN vs. OUTPUT VOLTAGE SWING

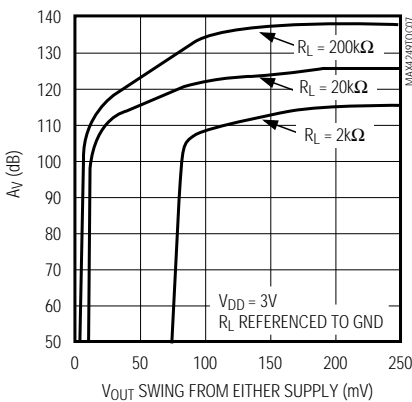

LARGE-SIGNAL VOLTAGE GAIN vs. OUTPUT VOLTAGE SWING

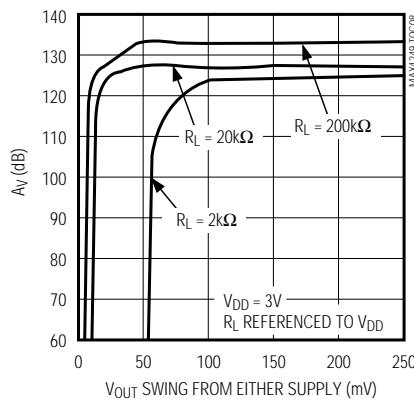

LARGE-SIGNAL VOLTAGE GAIN vs. OUTPUT VOLTAGE SWING

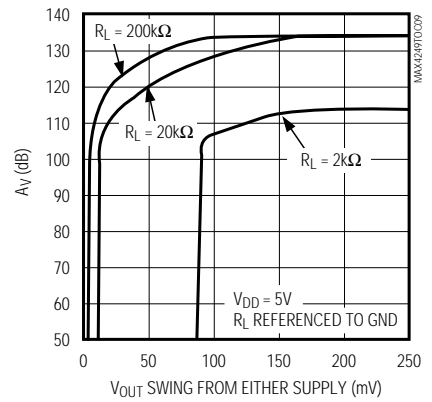

# SOT23, Single-Supply, Low-Noise, Low-Distortion, Rail-to-Rail Op Amps

MAX4249-MAX4257

## Typical Operating Characteristics (continued)

( $V_{DD} = +5V$ ,  $V_{SS} = 0V$ ,  $V_{CM} = V_{OUT} = V_{DD}/2$ , input noise floor of test equipment =  $10nV/\sqrt{Hz}$  for all distortion measurements,  $T_A = +25^\circ C$ , unless otherwise noted.)

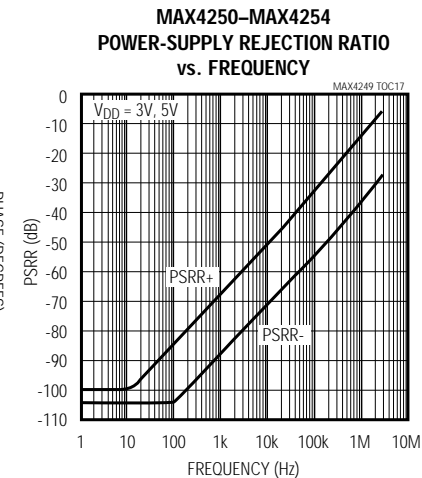
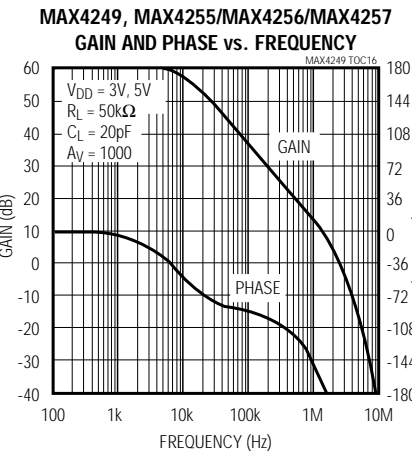
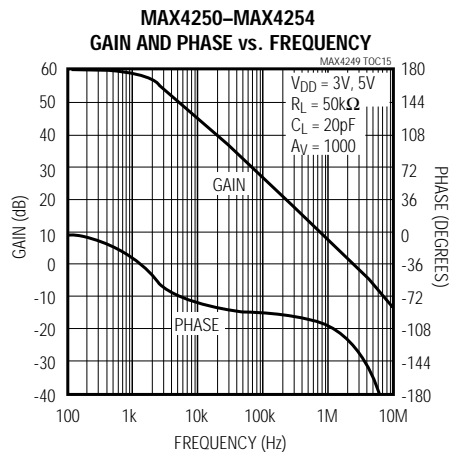
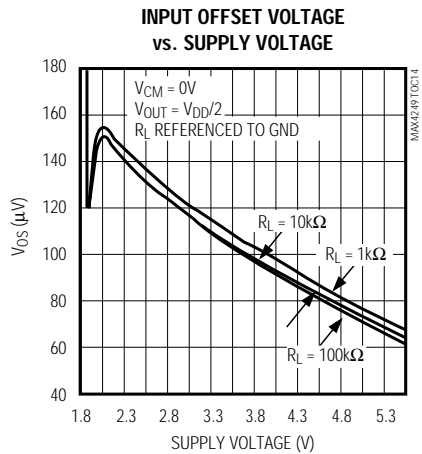
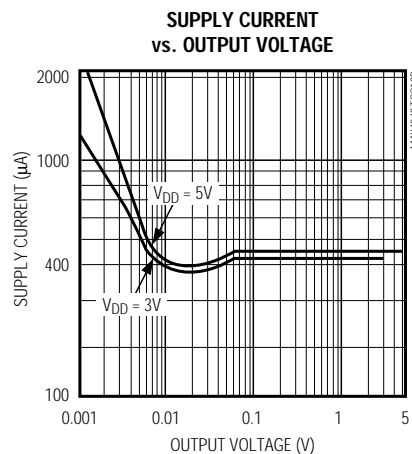
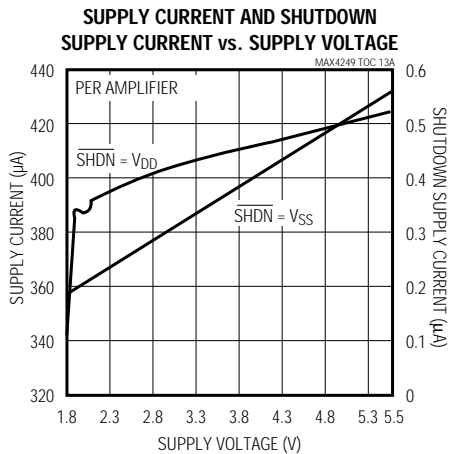
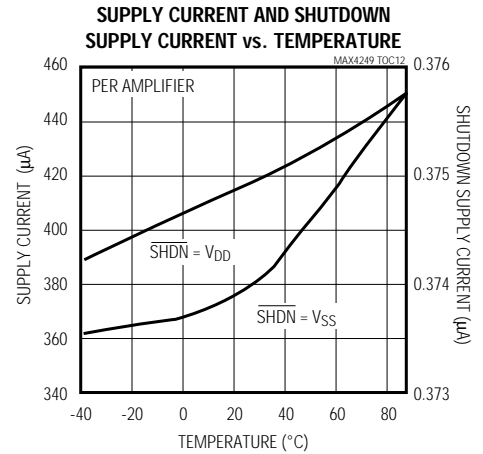
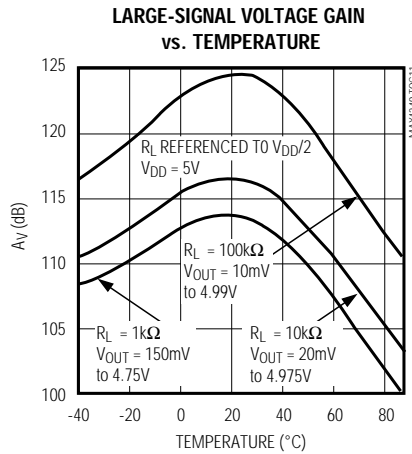
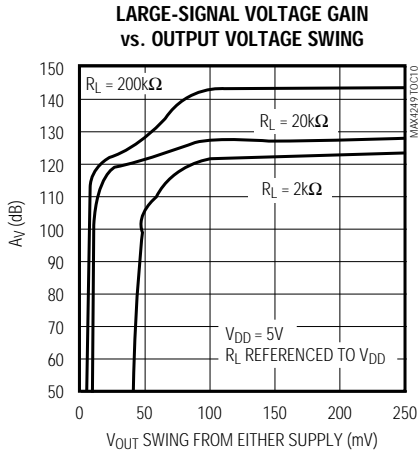

# SOT23, Single-Supply, Low-Noise, Low-Distortion, Rail-to-Rail Op Amps

## Typical Operating Characteristics (continued)

( $V_{DD} = +5V$ ,  $V_{SS} = 0V$ ,  $V_{CM} = V_{OUT} = V_{DD}/2$ , input noise floor of test equipment =  $10nV/\sqrt{Hz}$  for all distortion measurements,  $T_A = +25^\circ C$ , unless otherwise noted.)

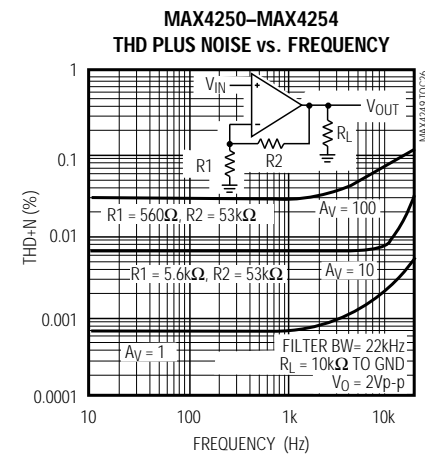
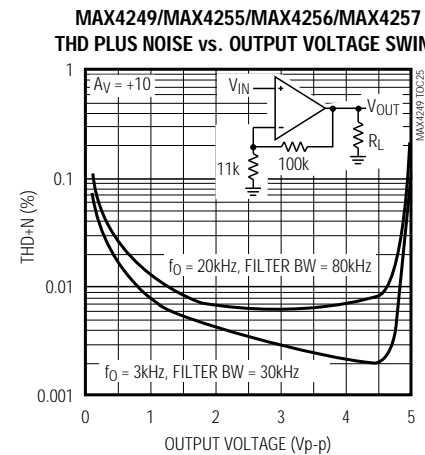
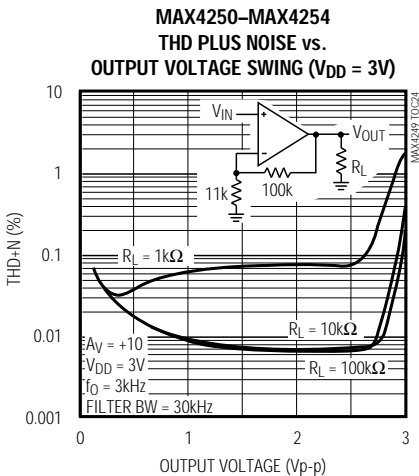
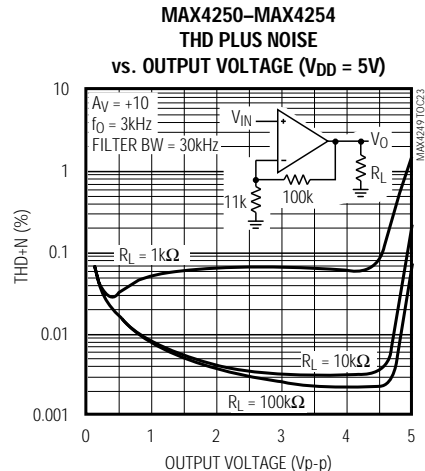
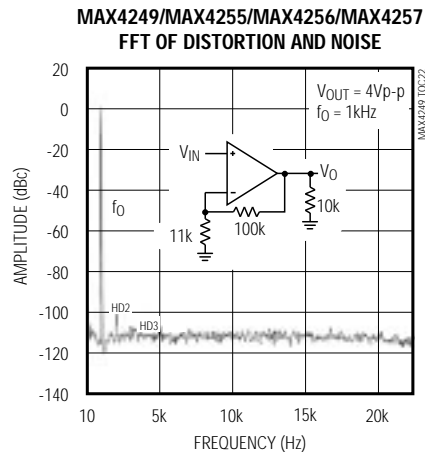
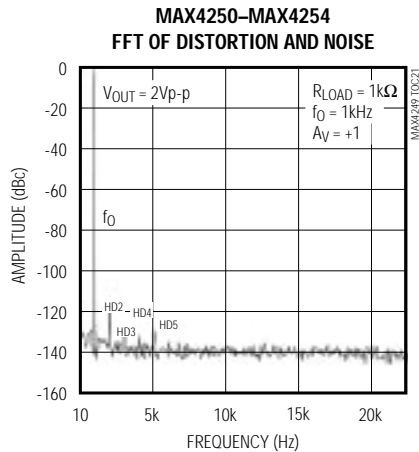
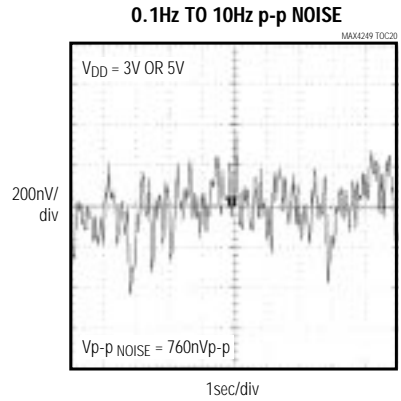
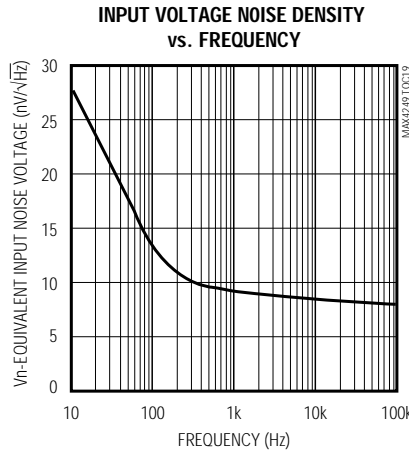
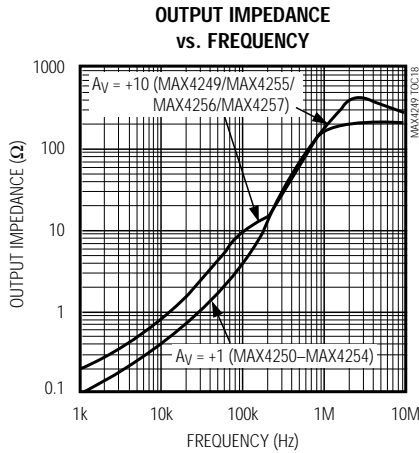

# SOT23, Single-Supply, Low-Noise, Low-Distortion, Rail-to-Rail Op Amps

MAX4249-MAX4257

## Typical Operating Characteristics (continued)

( $V_{DD} = +5V$ ,  $V_{SS} = 0V$ ,  $V_{CM} = V_{OUT} = V_{DD}/2$ , input noise floor of test equipment =  $10nV/\sqrt{Hz}$  for all distortion measurements,  $T_A = +25^\circ C$ , unless otherwise noted.)

**MAX4249/MAX4255-MAX4257  
TOTAL HARMONIC DISTORTION  
PLUS NOISE vs. FREQUENCY**

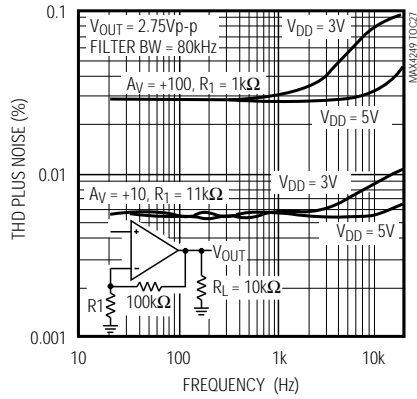

**MAX4250-MAX4254  
TOTAL HARMONIC DISTORTION  
PLUS NOISE vs. FREQUENCY**

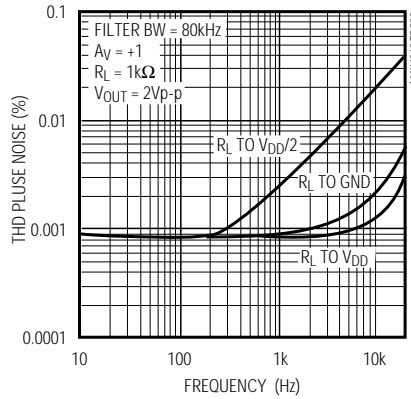

**MAX4250-MAX4254  
LARGE-SIGNAL PULSE RESPONSE**

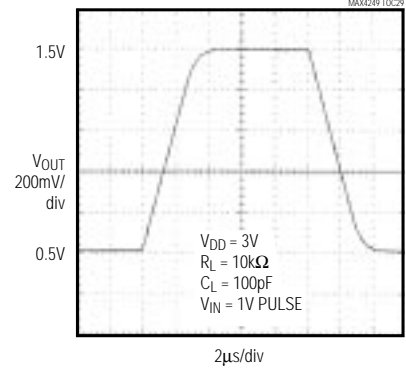

**MAX4250-MAX4254  
SMALL-SIGNAL PULSE RESPONSE**

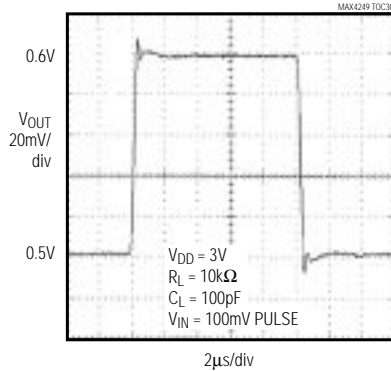

**MAX4249/MAX4255/MAX4256/MAX4257  
LARGE-SIGNAL PULSE RESPONSE**

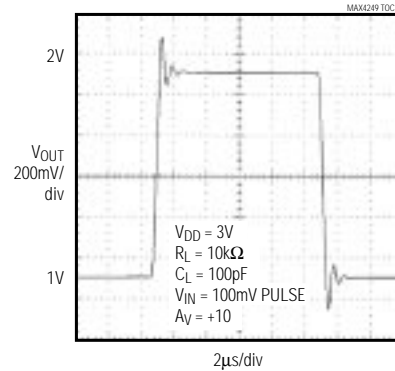

**MAX4249/MAX4255/MAX4256/MAX4257  
SMALL-SIGNAL PULSE RESPONSE**

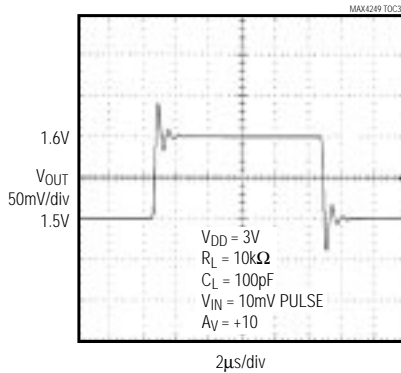

**MAX4252/MAX4253/MAX4254  
CHANNEL SEPARATION vs. FREQUENCY**

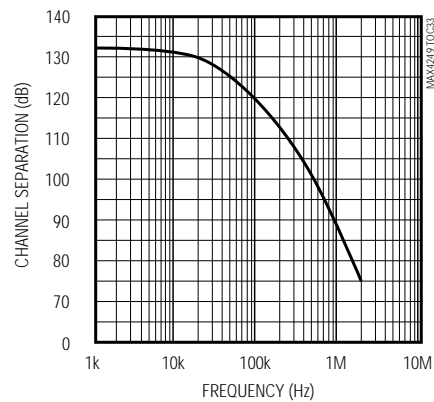

# SOT23, Single-Supply, Low-Noise, Low-Distortion, Rail-to-Rail Op Amps

## Pin Description

PIN						NAME	FUNCTION
MAX4250 MAX4255	MAX4251 MAX4256	MAX4252 MAX4257	MAX4249/MAX4253		MAX4254		
5 SOT23	8 $\mu$ MAX/SO		10 $\mu$ MAX	14 SO	14 SO		
1	6	1, 7	1, 9	1, 13	1, 7, 8, 14	OUT, OUTA, OUTB, OUTC, OUTD	Amplifier Output
2	4	4	4	4	11	V <sub>SS</sub>	Negative Supply. Connect to ground for single-supply operation.
3	3	3, 5	3, 7	3, 11	3, 5, 10, 12	IN+, INA+, INB+, INC+, IND+	Noninverting Amplifier Input
4	2	2, 6	2, 8	2, 12	2, 6, 9, 13	IN-, INA-, INB-, INC-, IND-	Inverting Amplifier Input
5	7	8	10	14	4	V <sub>DD</sub>	Positive Supply
—	8	—	5, 6	6, 9	—	$\overline{\text{SHDN}}$ , $\overline{\text{SHDNA}}$ , $\overline{\text{SHDNB}}$	Shutdown Input. Connect to V <sub>DD</sub> or leave unconnected for normal operation (amplifier(s) enabled).
—	1, 5	—	—	5, 7, 8, 10	—	N.C.	No Connection. Not internally connected.

## Detailed Description

The MAX4249-MAX4257 single-supply operational amplifiers feature ultra-low noise and distortion while consuming very little power. Their low distortion and low noise make them ideal for use as preamplifiers in wide dynamic-range applications, such as 16-bit analog-to-digital converters (see *Typical Operating Circuit*). Their high input impedance and low noise are also useful for signal conditioning of high-impedance sources, such as piezoelectric transducers.

These devices have true rail-to-rail output operation, drive loads as low as 1k $\Omega$  while maintaining DC accuracy, and can drive capacitive loads up to 400pF without oscillation. The input common-mode voltage range extends from V<sub>DD</sub> - 1.1V to 200mV beyond the negative rail. The push/pull output stage maintains excellent DC characteristics, while delivering up to  $\pm$ 5mA of current.

The MAX4250-MAX4254 are unity-gain stable, whereas the MAX4249/MAX4255/MAX4256/MAX4257 have a higher slew rate and are stable for gains  $\geq$ 10V/V. The MAX4249/MAX4251/MAX4253/MAX4256 feature a low-power shutdown mode, which reduces the supply current to 0.5 $\mu$ A and disables the outputs.

## Low Distortion

Many factors can affect the noise and distortion that the device contributes to the input signal. The following guidelines offer valuable information on the impact of design choices on Total Harmonic Distortion (THD).

Choosing proper feedback and gain resistor values for a particular application can be a very important factor in reducing THD. In general, the smaller the closed-loop gain, the smaller the THD generated, especially when driving heavy resistive loads. Large-value feedback resistors can significantly improve distortion. The THD of the part normally increases at approximately 20dB per decade, as a function of frequency. Operating the device near or above the full-power bandwidth significantly degrades distortion.

Referencing the load to either supply also improves the part's distortion performance, because only one of the MOSFETs of the push/pull output stage drives the output. Referencing the load to mid-supply increases the part's distortion for a given load and feedback setting. (See the Total Harmonic Distortion vs. Frequency graph in the *Typical Operating Characteristics*.)



# SOT23, Single-Supply, Low-Noise, Low-Distortion, Rail-to-Rail Op Amps

For gains  $\geq 10V/V$ , the decompensated devices (MAX4249/MAX4255/MAX4256/MAX4257) deliver the best distortion performance, since they have a higher slew rate and provide a higher amount of loop gain for a given closed-loop gain setting. Capacitive loads below 400pF do not significantly affect distortion results. Distortion performance remains relatively constant over supply voltages.

### Low Noise

The amplifier's input-referred noise voltage density is dominated by flicker noise at lower frequencies, and by thermal noise at higher frequencies. Because the thermal noise contribution is affected by the parallel combination of the feedback resistive network ( $R_F || R_G$ , Figure 1), these resistors should be reduced in cases where the system bandwidth is large and thermal noise is dominant. This noise-contribution factor decreases, however, with increasing gain settings.

For example, the input noise voltage density of the circuit with  $R_F = 100k\Omega$ ,  $R_G = 11k\Omega$  ( $A_V = 10V/V$ ) is  $e_n = 15nV/\sqrt{Hz}$ .  $e_n$  can be reduced to  $9nV/\sqrt{Hz}$  by choosing  $R_F = 10k\Omega$ ,  $R_G = 1.1k\Omega$  ( $A_V = 10V/V$ ), at the expense of greater current consumption and potentially higher distortion. For a gain of  $100V/V$  with  $R_F = 100k\Omega$ ,  $R_G = 1.1k\Omega$ , the  $e_n$  is low ( $9nV/\sqrt{Hz}$ ).

### Using a Feed-Forward Compensation Capacitor, $C_z$

The amplifier's input capacitance is 11pF. If the resistance seen by the inverting input is large (feedback network), this can introduce a pole within the amplifier's bandwidth, resulting in reduced phase margin. Compensate the reduced phase margin by introducing a feed-forward capacitor ( $C_z$ ) between the inverting input and the output (Figure 1). This effectively cancels the pole from the inverting input of the amplifier. Choose the value of  $C_z$  as follows:

$$C_z \approx 11 \times (R_F / R_G) \text{ [pF]}$$

In the unity-gain-stable MAX4250-MAX4254, the use of a proper  $C_z$  is most important for  $A_V = +2V/V$ , and  $A_V = -1V/V$ . In the decompensated MAX4249/MAX4255/MAX4256/MAX4257,  $C_z$  is most important for  $A_V = \pm 10V/V$ . Figures 2a and 2b show transient response both with and without  $C_z$ .

Using a slightly smaller  $C_z$  than suggested by the formula above achieves a higher bandwidth at the expense of reduced phase and gain margin. As a general guideline, consider using  $C_z$  for cases where  $R_G || R_F$  is greater than  $20k\Omega$  (MAX4250-MAX4254) or greater than  $5k\Omega$  (MAX4249/MAX4255/MAX4256/MAX4257).

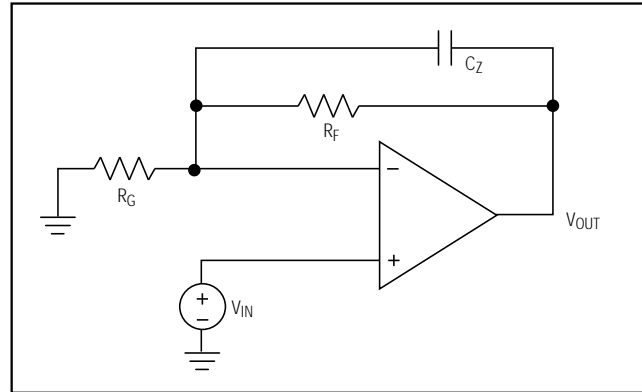

Figure 1. Adding Feed-Forward Compensation

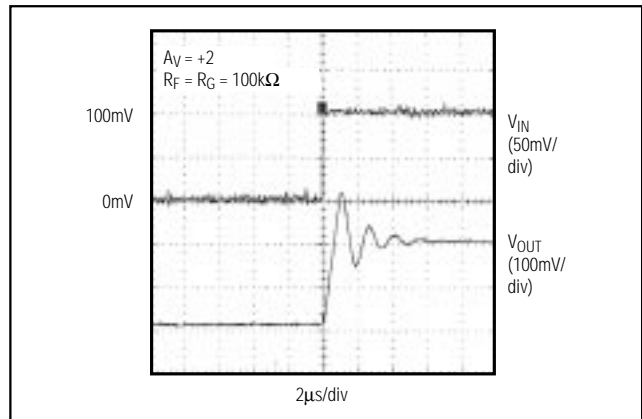

Figure 2a. Pulse Response with No Feed-Forward Compensation

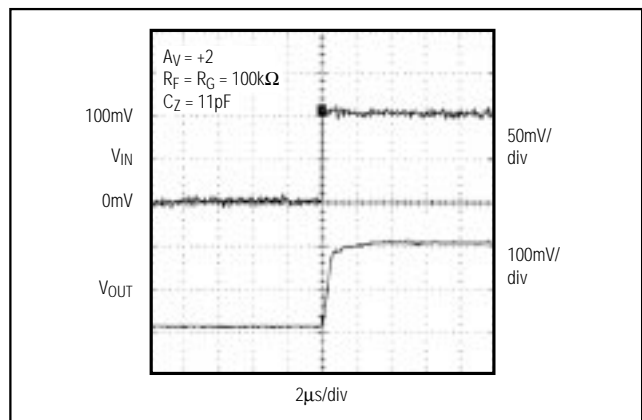

Figure 2b. Pulse Response with 10pF Feed-Forward Compensation

# SOT23, Single-Supply, Low-Noise, Low-Distortion, Rail-to-Rail Op Amps

## Applications Information

The MAX4249-MAX4257 combine good driving capability with ground-sensing input and rail-to-rail output operation. With their low distortion, low noise and low power consumption, they are ideal for use in portable instrumentation systems and other low-power, noise-sensitive applications.

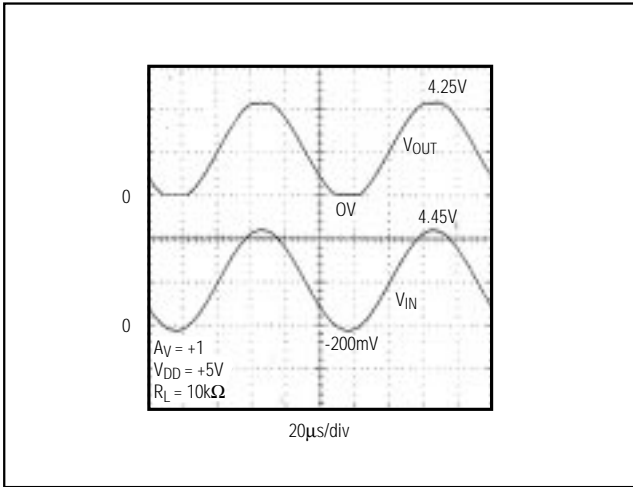

Figure 3. Overdriven Input Showing No Phase Reversal

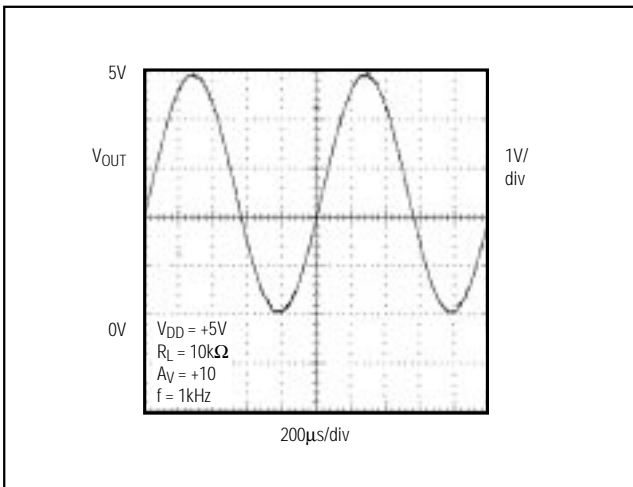

Figure 4. Rail-to-Rail Output Operation

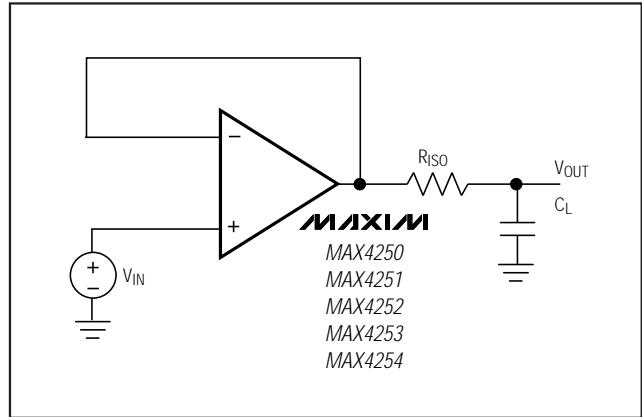

Figure 5. Capacitive-Load Driving Circuit

### Ground-Sensing and Rail-to-Rail Outputs

The common-mode input range of the MAX4249-MAX4257 extends down to ground, and offers excellent common-mode rejection. These devices are guaranteed not to undergo phase reversal when the input is overdriven (Figure 3).

Figure 4 showcases the true rail-to-rail output operation of the amplifier, configured with  $A_V = 10V/V$ . The output swings to within 8mV of the supplies with a 10k $\Omega$  load, making the devices ideal in low-supply-voltage applications.

### Output Loading and Stability

Even with their low quiescent current of 400 $\mu A$ , these amplifiers can drive 1k $\Omega$  loads while maintaining excellent DC accuracy. Stability while driving heavy capacitive loads is another key feature.

These devices maintain stability while driving loads up to 400pF. To drive higher capacitive loads, place a small isolation resistor in series between the output of the amplifier and the capacitive load (Figure 5). This resistor improves the amplifier's phase margin by isolating the capacitor from the op amp's output. Reference Figure 6 to select a resistance value that will ensure a load capacitance that limits peaking to <2dB (25%). For example, if the capacitive load is 1000pF, the corresponding isolation resistor is 150 $\Omega$ . Figure 7 shows that peaking occurs without the isolation resistor. Figure 8 shows the unity-gain bandwidth vs. capacitive load for the MAX4250-MAX4254.

### Power Supplies and Layout

The MAX4249-MAX4257 operate from a single +2.4V to +5.5V power supply or from dual supplies of  $\pm 1.20V$  to  $\pm 2.75V$ . For single-supply operation, bypass the

# SOT23, Single-Supply, Low-Noise, Low-Distortion, Rail-to-Rail Op Amps

MAX4249-MAX4257

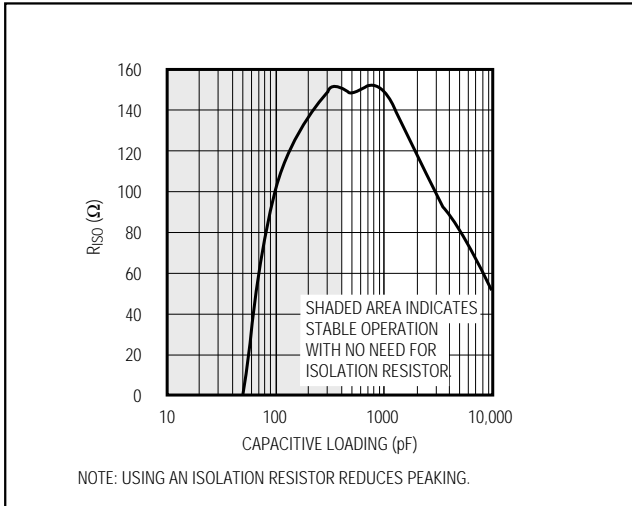

Figure 6. Isolation Resistance vs. Capacitive Loading to Minimize Peaking (<2dB)

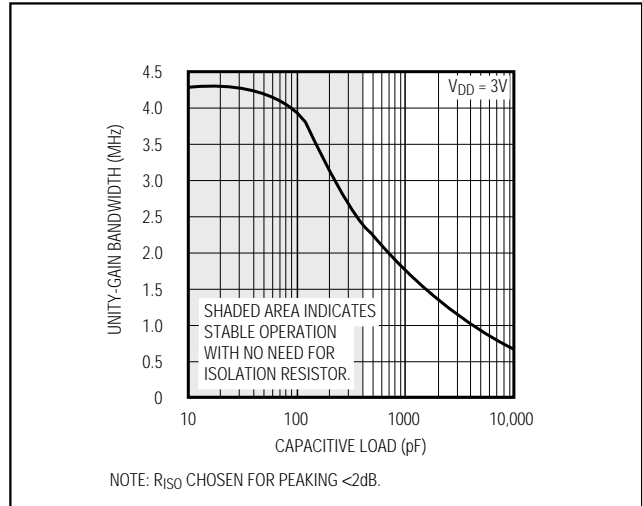

Figure 8. MAX4250-MAX4254 Unity-Gain Bandwidth vs. Capacitive Load

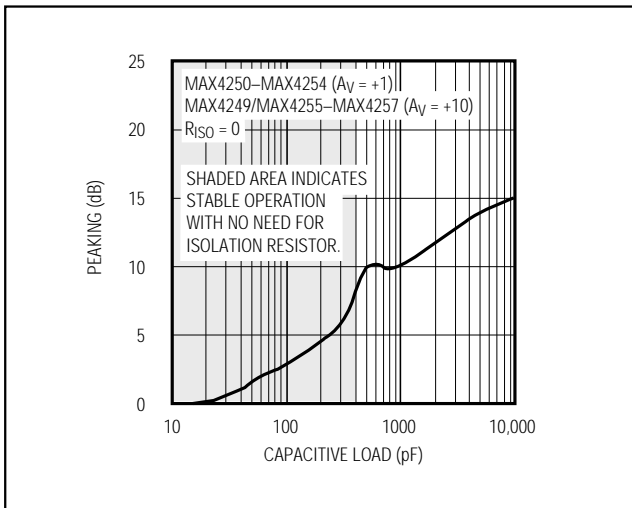

Figure 7. Peaking vs. Capacitive Load

power supply with a 0.1μF ceramic capacitor placed close to the V<sub>DD</sub> pin. If operating from dual supplies, bypass each supply to ground.

Good layout improves performance by decreasing the amount of stray capacitance and noise at the op amp's inputs and output. To decrease stray capacitance, minimize PC board trace lengths and resistor leads, and place external components close to the op amp's pins.

## Chip Information

### TRANSISTOR COUNTS:

MAX4250/MAX4251/MAX4255/MAX4256: 170

MAX4249/MAX4252/MAX4253/MAX4257: 340

MAX4254: 680

## Ordering Information (continued)

PART	TEMP. RANGE	PIN-PACKAGE	SOT TOP MARK
<b>MAX4251</b> ESA	-40°C to +85°C	8 SO	—
MAX4251EUA	-40°C to +85°C	8 μMAX	—
<b>MAX4252</b> ESA	-40°C to +85°C	8 SO	—
MAX4252EUA	-40°C to +85°C	8 μMAX	—
<b>MAX4253</b> EUB	-40°C to +85°C	10 μMAX	—
MAX4253ESD	-40°C to +85°C	14 SO	—
<b>MAX4254</b> ESD	-40°C to +85°C	14 SO	—
<b>MAX4255</b> EUK-T	-40°C to +85°C	5 SOT23-5	ACCJ
<b>MAX4256</b> ESA	-40°C to +85°C	8 SO	—
MAX4256EUA	-40°C to +85°C	8 μMAX	—
<b>MAX4257</b> ESA	-40°C to +85°C	8 SO	—
MAX4257EUA	-40°C to +85°C	8 μMAX	—

# SOT23, Single-Supply, Low-Noise, Low-Distortion, Rail-to-Rail Op Amps

## Pin Configurations

TOP VIEW

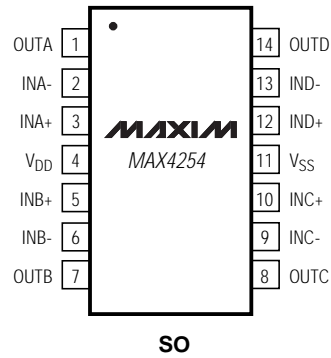
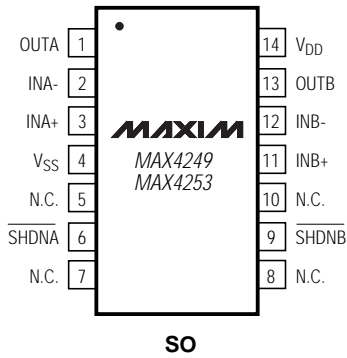
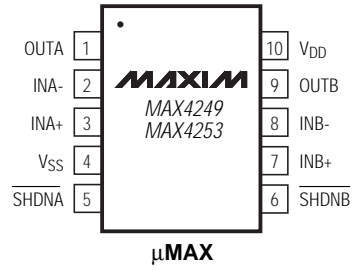
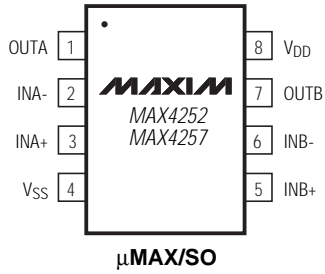
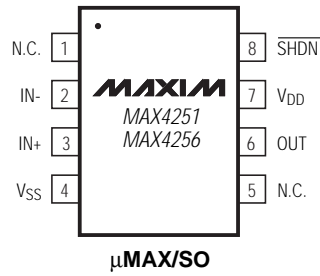
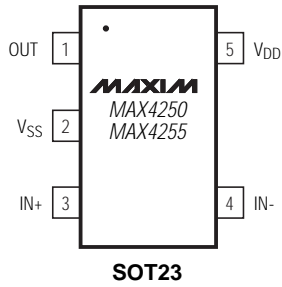

# SOT23, Single-Supply, Low-Noise, Low-Distortion, Rail-to-Rail Op Amps

Typical Operating Circuit

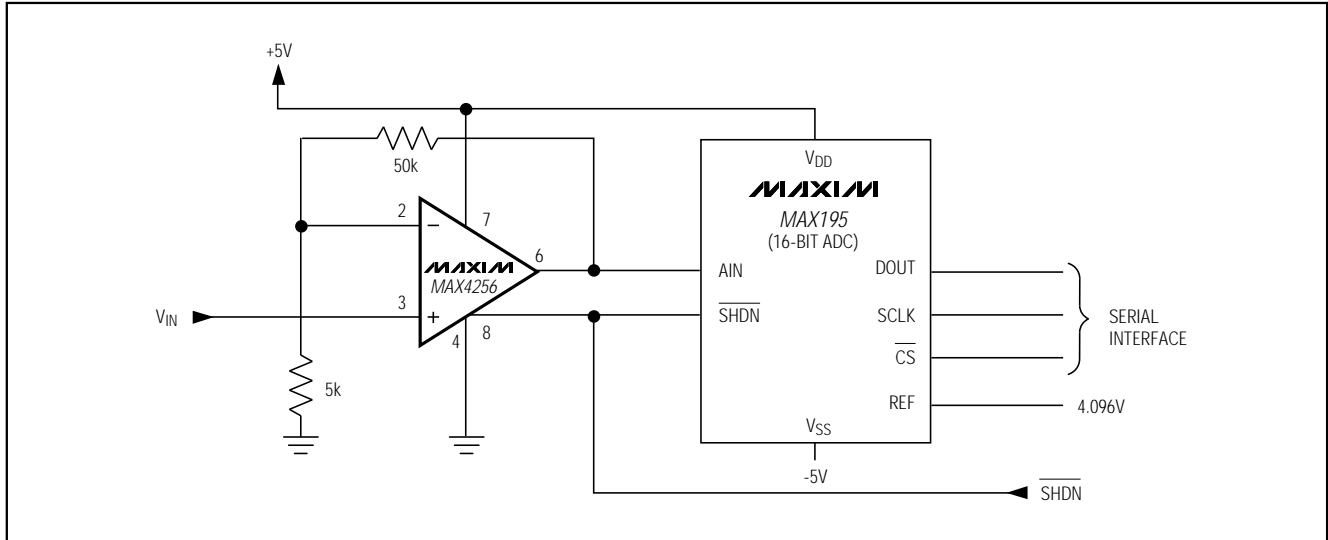

MAX4249-MAX4257

# SOT23, Single-Supply, Low-Noise, Low-Distortion, Rail-to-Rail Op Amps

## Package Information

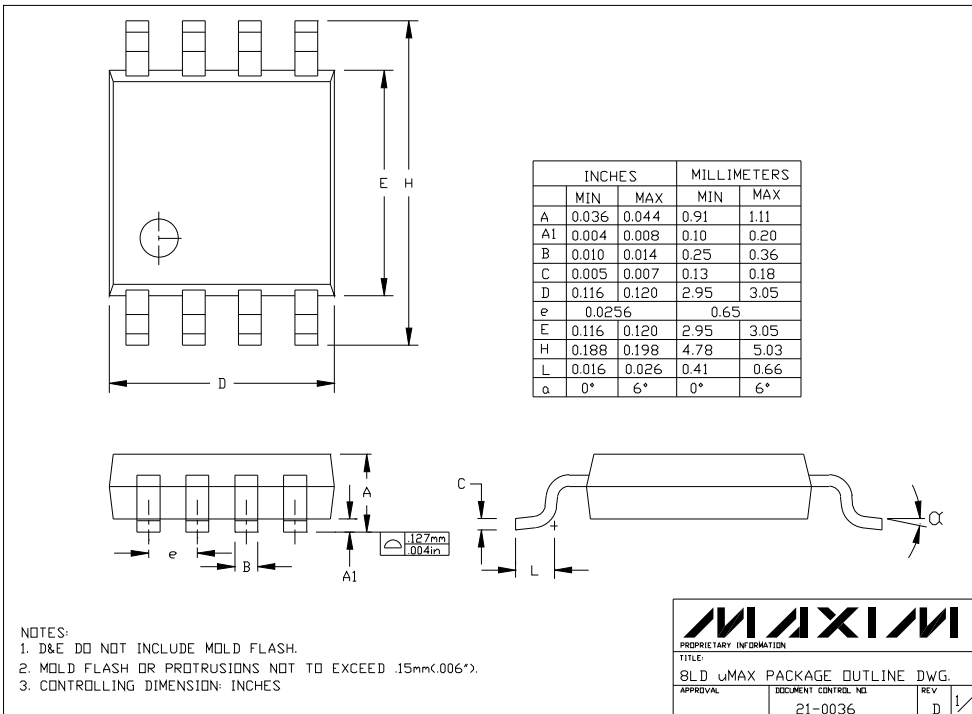
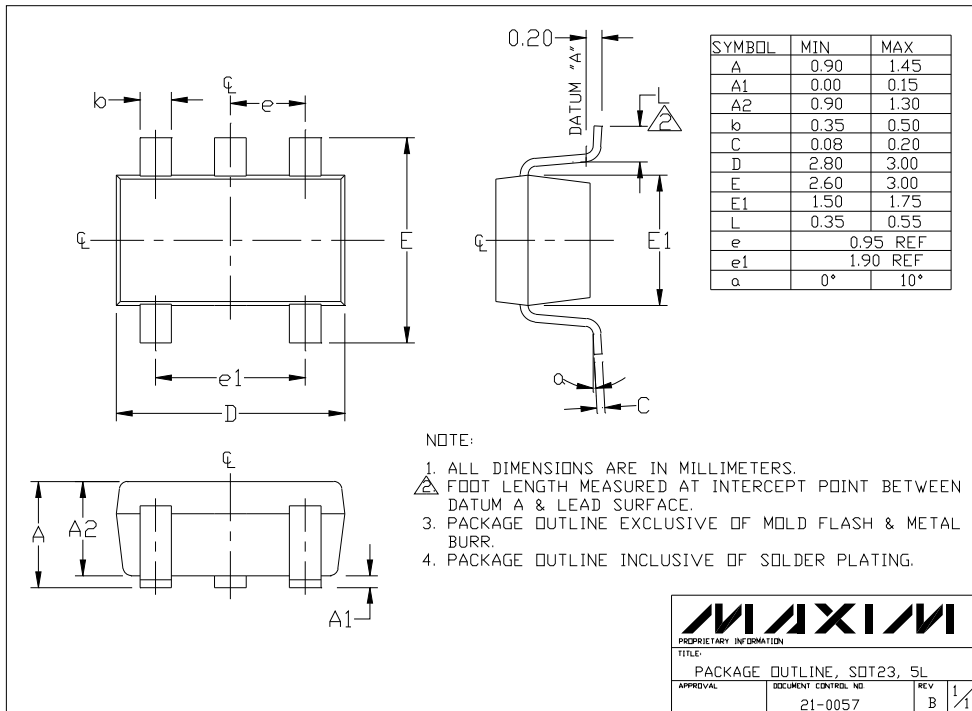

# SOT23, Single-Supply, Low-Noise, Low-Distortion, Rail-to-Rail Op Amps

Package Information (continued)

MAX4249-MAX4257

10LUMAXB.EPS

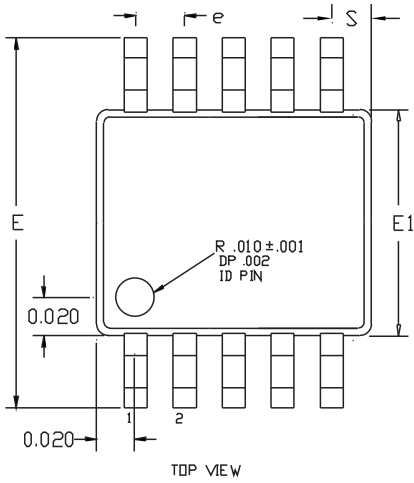

DIM	INCHES		MILLIMETERS	
	MIN	MAX	MIN	MAX
A	0.037	0.043	0.939	1.092
A1	0.002	0.006	0.051	0.152
A2	0.030	0.038	0.762	0.965
D1	0.112	0.124	2.845	3.150
D2	0.110	0.122	2.794	3.099
E1	0.112	0.124	2.845	3.150
E2	0.110	0.122	2.794	3.099
E	0.185	0.201	4.699	5.105
L	0.0155	0.0275	0.394	0.699
L1	0.037	REF	0.940	REF
b	0.007	0.0106	0.177	0.270
e	0.0197	BSC	.500	BSC
c	0.0035	0.0078	0.090	0.200
S	0.0196	REF	.498	REF
$\alpha$	0°	6°	0°	6°

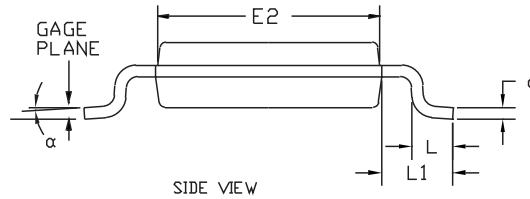
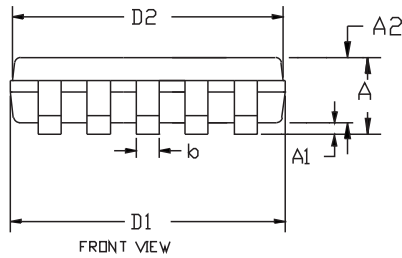

NOTES:

1. D&E DO NOT INCLUDE MOLD FLASH.
2. MOLD FLASH OR PROTRUSIONS NOT TO EXCEED .15mm(.006").
3. CONTROLLING DIMENSION: INCHES

<b>MAXIM</b>			
<small>PROPRIETARY INFORMATION</small>			
<small>TITLE:</small>			
PACKAGE OUTLINE, 10L MICRO MAX			
<small>APPROVAL</small>	<small>DOCUMENT CONTROL NO.</small>	<small>REV</small>	<small>1/1</small>
	21-0061	B	

# SOT23, Single-Supply, Low-Noise, Low-Distortion, Rail-to-Rail Op Amps

Package Information (continued)

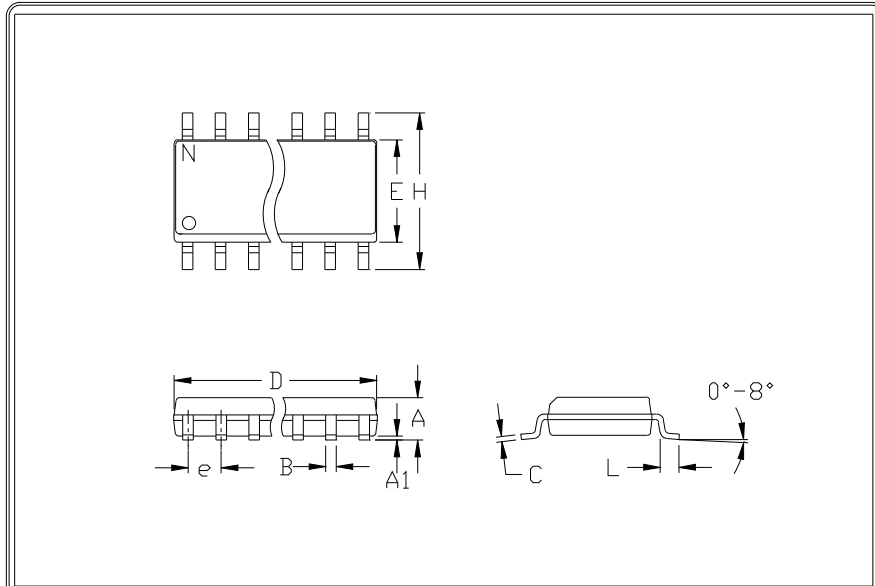

	INCHES		MILLIMETERS	
	MIN	MAX	MIN	MAX
A	0.053	0.069	1.35	1.75
A1	0.004	0.010	0.10	0.25
B	0.014	0.019	0.35	0.49
C	0.007	0.010	0.19	0.25
e	0.050		1.27	
E	0.150	0.157	3.80	4.00
H	0.228	0.244	5.80	6.20
h	0.010	0.020	0.25	0.50
L	0.016	0.050	0.40	1.27

	INCHES		MILLIMETERS		N	MS012
	MIN	MAX	MIN	MAX		
D	0.189	0.197	4.80	5.00	8	A
D	0.337	0.344	8.55	8.75	14	B
D	0.386	0.394	9.80	10.00	16	C

- NOTES:
1. D&E DO NOT INCLUDE MOLD FLASH
  2. MOLD FLASH OR PROTRUSIONS NOT TO EXCEED .15mm (.006")
  3. LEADS TO BE COPLANAR WITHIN .102mm (.004")
  4. CONTROLLING DIMENSION: MILLIMETER
  5. MEETS JEDEC MS012-XX AS SHOWN IN ABOVE TABLE
  6. N = NUMBER OF PINS



PACKAGE FAMILY OUTLINE: SOIC .150"

1/1

21-0041 A  
DOCUMENT CONTROL NUMBER REV

Maxim cannot assume responsibility for use of any circuitry other than circuitry entirely embodied in a Maxim product. No circuit patent licenses are implied. Maxim reserves the right to change the circuitry and specifications without notice at any time.

16 Maxim Integrated Products, 120 San Gabriel Drive, Sunnyvale, CA 94086 408-737-7600